

ONL843NW3
For Model: NL843NW3

OPERATOR'S MANUAL

Marine Generators | Marine Diesel Engines | Land-Based Generators



NORTHERN LIGHTS





As of January 2008, U.S. EPA regulations require the application of a permanently applied label near the fuel tank fill port for diesel driven equipment. This label is to state:

LOW OR ULTRA LOW SULFUR FUEL ONLY

Northern Lights is providing this label for application to the fuel inlet of the fuel supply tank for each engine or generator set. This is to be applied by the installer of the engine or gen set, or by the manufacturer of the equipment that the engine or gen set is installed in. The location of the label must be in clear site of personnel that refill the supply tank.

Note: Starting in 2011, the label will state:
ULTRA LOW SULFUR ONLY.



— CALIFORNIA —
Proposition 65 Warning:

Diesel engine exhaust and some of its constituents are known to the State of California to cause cancer, birth defects, and other reproductive harm.

Northern Lights

4420 14th Avenue N.W.
Seattle, WA 98107
Tel: (206) 789-3880
Fax: (206) 782-5455

Copyright ©2013 Northern Lights, Inc.
All rights reserved. Northern Lights™, and
the Northern Lights logo are trademarks of
Northern Lights, Inc.

Printed in U.S.A.
PART NO.: ONL843NW3 11/13



NORTHERN LIGHTS

OPERATOR'S MANUAL

for Model NL843NW3

*Read this operator's manual thoroughly before starting to operate your equipment.
This manual contains information you will need to run and service your new unit.*

Table of Contents

<p>INTRODUCTION 2</p> <p style="padding-left: 20px;">Models Included..... 2</p> <p style="padding-left: 20px;">Model Numbers..... 2</p> <p style="padding-left: 20px;">Serial Numbers..... 2</p> <p>WARRANTY 3</p> <p>SAFETY RULES 3 - 7</p> <p>COMPONENT LOCATIONS</p> <p style="padding-left: 20px;">NL843NW3 Industrial Generator 8</p> <p>CONTROL PANELS</p> <p style="padding-left: 20px;">Northern Lights Generator Sets..... 9</p> <p>OPERATING PROCEDURES</p> <p style="padding-left: 20px;">Break-in Period 10</p> <p style="padding-left: 20px;">Before Starting 10</p> <p style="padding-left: 20px;">Starting..... 10</p> <p style="padding-left: 20px;">Operating..... 10</p> <p style="padding-left: 20px;">Stopping 10</p> <p style="padding-left: 20px;">Shutdowns and Alarms..... 11</p> <p style="padding-left: 20px;">Spare Parts..... 11</p> <p>SERVICING SCHEDULE CHART 12</p> <p>SERVICING</p> <p style="padding-left: 20px;">Lubrication - General 14</p> <p style="padding-left: 20px;">Checking Oil..... 14</p> <p style="padding-left: 20px;">Oil Changes 14</p> <p style="padding-left: 20px;">Changing Oil Filter..... 14</p> <p style="padding-left: 20px;">Air Filter..... 15</p>	<p>SERVICING (continued)</p> <p style="padding-left: 20px;">V-Belts 15</p> <p style="padding-left: 20px;">Valve Clearances 16</p> <p style="padding-left: 20px;">Fuels - General 16</p> <p style="padding-left: 20px;">Fuel Filters..... 16</p> <p style="padding-left: 20px;">Bleeding the Fuel System 17</p> <p style="padding-left: 20px;">Injector Service 18 - 19</p> <p style="padding-left: 20px;">Injection Pump 20</p> <p style="padding-left: 20px;">Cooling System - General..... 20</p> <p style="padding-left: 20px;">Cooling System Flushing 21</p> <p style="padding-left: 20px;">Generator Ends..... 21</p> <p style="padding-left: 20px;">Electrical System - General 22</p> <p style="padding-left: 20px;">Glow Plugs 22</p> <p style="padding-left: 20px;">Booster Batteries 23</p> <p style="padding-left: 20px;">Battery Care..... 23</p> <p style="padding-left: 20px;">Winterizing / Out-of-Service..... 23</p> <p>TROUBLESHOOTING</p> <p style="padding-left: 20px;">Electrical 24</p> <p style="padding-left: 20px;">Engine..... 25 - 27</p> <p>DATA SHEETS</p> <p style="padding-left: 20px;">NL843NW3 28</p> <p>WIRING DIAGRAMS</p> <p style="padding-left: 20px;">AC Electrical 29 - 30</p> <p style="padding-left: 20px;">DC Electrical 31 - 33</p>
---	--

Proprietary Information

This publication is the property of Northern Lights, Inc.
It may not be reproduced in whole or in part without the written permission of Northern Lights, Inc.
© Northern Lights, Inc. All rights reserved. Litho U.S.A. Publication number ONL843NW3 11/13

Introduction

Servicing of generator sets presents unique problems. In many cases boats cannot be moved to a repair facility. Generators cannot be compared to the servicing of automobiles, trucks or even farm equipment. Failures often occur in remote areas far from competent assistance. Generator sets are taxed far more severely than auto or truck engines; therefore, maintenance schedules must be adhered to more strictly.

Failures can begin with minor problems that are overlooked and become amplified when not corrected during routine maintenance.

As operator, it is your obligation to learn about your equipment and its proper maintenance. This is not a comprehensive technical service manual. Nor will it make the reader into an expert mechanic. Its aim is to aid you in maintaining your unit properly.

Unit Identification

MODELS INCLUDED

This manual covers the operating instructions for:

NL843NW3 industrial generator set

Fill in the model number of your unit in the blank space provided.

This will give you a reference whenever service or maintenance is required:

My Northern Lights generator set MODEL number is:

Model Numbers

Model numbers give the unit's application, block model, aspiration, and RPM:

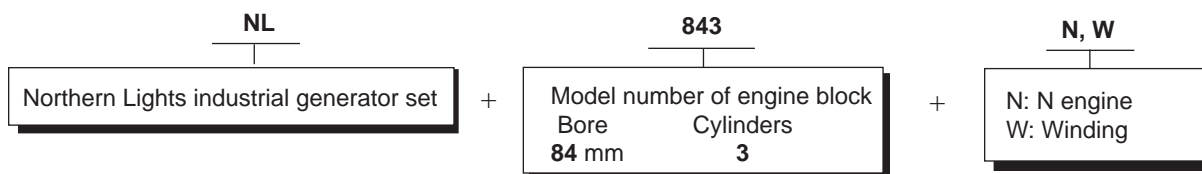

NL843NW3 = Northern Lights industrial diesel generator set with an 843N engine and a PX-312K2 generator end, Tier III.

Serial Numbers



Your set has three serial numbers: ① an engine number stamped on the block, ② a generator plate, and ③ a generator set plate.

Use the serial number on the generator set plate when ordering parts or in correspondence. The generator set plate is found on the service side of the generator and resembles the drawing in Figure 1.

Figure 1: Generator set serial number plate.

Warranty

A warranty registration certificate is supplied with your set. It entitles the original purchaser of our equipment to a warranty covering material or assembly faults. The extent of coverage is described in the Limited Warranty Statement. We recommend that you study the statement carefully.

NOTE: If the warranty is to apply, the servicing instructions outlined in this manual must be followed. If further information is needed, please contact an authorized dealer or the factory.

Safety Rules



CAUTION: Accident reports show that careless use of engines causes a high percentage of accidents. You can avoid accidents by observing these safety rules. Study these rules carefully and enforce them on the job.

IMPORTANT SAFETY INSTRUCTIONS.

Electromagnetic equipment, including generator sets and their accessories, can cause bodily harm and life threatening injuries when improperly installed, operated or maintained. To prevent accidents be aware of potential dangers and act safely.

READ AND FOLLOW ALL SAFETY INSTRUCTIONS IN THIS MANUAL, PRIOR TO THE INSTALLATION OF ANY GENERATOR SET OR ACCESSORY. KEEP THESE INSTRUCTIONS FOR FUTURE REFERENCE.

Recognize Safety Symbols and Instructions

In addition to the information found in this section, this operator's manual will use the CAUTION warning to outline potential dangers of a specific nature.



CAUTION indicates the presence of a potential hazard that can or will cause severe or minor property damage, personal injury or death.

Follow All Safety Instructions

Carefully read and understand all safety messages in this manual and on your machine's safety signs. Keep signs in good and clean condition. Replace missing or damaged signs. Be sure new equipment components and

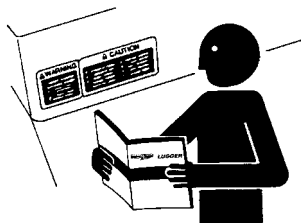

repair parts include the current safety signs. For replacement signs, proper placement of safety signs or clarification on any safety issue, consult your Northern Lights dealer or the factory.

There can be additional safety information contained on parts and components from outside suppliers that is not reproduced in this manual. Consult the suppliers for additional safety information.

Learn how to operate the machine and how to use the controls properly. Only trained personnel should operate machines, or work on or around them.

Keep you machine in proper working condition. **UNAUTHORIZED MODIFICATIONS TO THE MACHINERY MAY IMPAIR ITS FUNCTION AND SAFETY PARAMETERS.**

Prevent Bypass and Accidental Starting

Do not start engine by shorting across start terminal. Engine will start if normal circuitry is bypassed, creating a hazard by runaway machinery.



Start engine only from operator's station.

Handle Fuel Safely - Avoid Flames

Diesel is highly flammable and should be treated with care at all times. Do not refuel while smoking or when near sparks or open flame.

Safety Rules

ALWAYS STOP ENGINE BEFORE FUELING MACHINE.

Always fill portable fuel tank outdoors. Never fuel a hot engine.



Prevent accidental discharge of starting fluids by storing all cans in a cool, safe place, away from sparks or open flame. Store with cap securely on container. Never incinerate or puncture a fuel container.

Prevent fires by keeping machine clean of accumulated trash, grease and debris. Always clean any spilled fuel as swiftly as possible. Do not store oily rags, which can ignite and burn spontaneously.

Be prepared if a fire starts. Keep a first aid kit and fire extinguisher handy. Keep emergency contact numbers for fire department, doctors, ambulance and hospital near the telephone.

Service Machines Safely

Do not wear a necktie, scarf, necklace, rings or other jewelry, or any loose clothing when working near moving parts. Tie long hair behind your head. If any of these items get caught in moving machinery, severe injury or death could result.

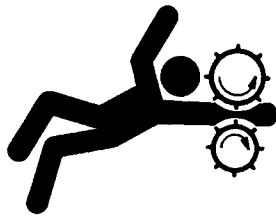

Check for any loose electrical connections or faulty wiring.

Look completely around engine to make sure that everything is clear before starting.

Wear Protective Clothing

To prevent catching anything in moving machinery, always wear close fitting clothes and safety equipment appropriate to the job.

Prolonged exposure to loud noise can cause hearing loss or impairment. Wear suitable

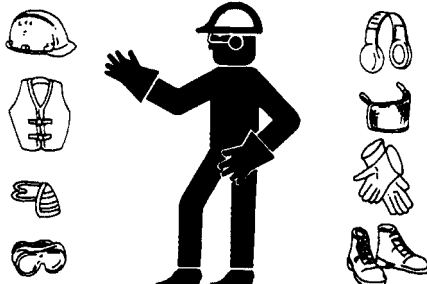

authorized hearing protection, such as earmuffs or plugs to protect against loud noises.

Operating equipment requires the full attention of the operator. Do not use radio or music headphones while operating machinery.

Practice Safe Maintenance

Understand all service procedures before starting work. Keep area clean and dry. Never lubricate, service, or adjust machine while it is in operation.

Keep hands, feet and clothing away from power-driven equipment. When shutting down an engine, disengage all power and operator controls. Allow the engine to cool completely before beginning any service work.



Securely support any machinery elements that must be raised for service work with support or lifting machinery specifically intended for that purpose.

Keep all parts in good conditions and properly installed. Fix damage immediately. Replace any worn or broken parts. Remove any build up of grease, oil or debris.

Disconnect battery ground cable (-) before making any adjustments or service work.

Stay Clear of Rotating Drivelines

Entanglement in rotating drivelines can cause serious injury or death. Keep shields in place at all times. Make sure that rotating shields turn freely in pace with the drivelines.



Do not wear loose fitting equipment around rotating drivelines. Stop the engine and make sure that all moving parts have stopped before making any adjustments, connections, or performing any other type of service to the engine or other driven equipment.

Safety Rules (Continued)

Install all Safety Guards

Direct contact with rotating fans, belts, pulley and drives can cause serious injury.

Keep all guards in place at all times during engine operation.

Wear close-fitting clothes. Stop the engine and be sure all fans, belts, pulleys and drives are stopped before making adjustments, connections, or cleaning near fans and their components.



Do not allow anything on your person to dangle into or come in contact with a moving fan, belt, pulley or drive. Fans can act as vacuums and pull materials up from below, so avoid that area as well while in service.

Safe Battery Handling

Prevent Battery Explosions

Battery gas is highly flammable. Battery explosions can cause severe injury or death. To help prevent battery explosions, keep sparks, lighted matches and open flame away from the top of battery. When checking battery electrolyte level, use a flashlight.

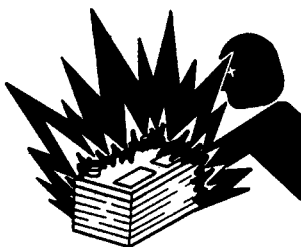

Never check battery charge by contacting the posts with a metal object. Use a volt-meter or hydrometer.

Frozen batteries may explode if charged. Never charge a battery that has not been allowed to warm to at least 16°C (60°F).

Always remove grounded (-) battery clamp first and replace ground clamp last.

Sulfuric acid in battery electrolyte is poisonous and strong enough to burn skin, eat holes into clothing and other materials, and cause blindness if splashed into eyes.

To Avoid Hazards:

- Fill batteries only in well-ventilated areas.
- Wear appropriate eye protection and rubber gloves.
- Never use air pressure to clean batteries.
- Wear appropriate ventilation equipment to avoid inhaling fumes when adding electrolyte.
- Do not spill or drip electrolyte.
- Use correct jump-start procedure if required.

If acid is spilled on skin or in eyes:

1. Flush skin with water.
2. Apply baking soda or lime to help neutralize acid.
3. Flush eyes with water for 15-30 minutes.
4. Get medical attention immediately.

If acid is swallowed:

1. DO NOT induce vomiting.
2. Drink large amounts of water or milk, without exceeding 2 liters (2 quarts)
3. Get medical attention immediately

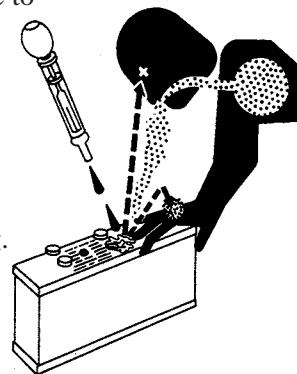

WARNING: Battery posts, terminals, and related accessories can contain lead and lead compounds, chemicals known to the State of California to cause cancer and reproductive harm. Wash hands after handling.

Handle Chemical Products Safely

Direct exposure to hazardous chemicals can cause serious injury. Among the potentially hazardous chemicals that may be used with Northern Lights products are lubricants, coolants, paints and adhesives.



All potentially hazardous chemicals come with a Material Data Safety Sheet (MSDS). The MSDS provides specific details on chemical products, including physical hazards, safety procedures and emergency response techniques.

Read and understand the MSDS for each chemical before you start any job that includes it. Follow the procedures and use appropriate equipment exactly as recommended.

Safety Rules (Continued)

Contact your Northern Lights dealer or Northern Lights factory for MSDS's used on Northern Lights products.

Work in Well Ventilated Areas

Exhaust fumes from engines contain carbon monoxide and can cause sickness or death. Work in well ventilated areas to avoid prolonged exposure to engine fumes. If it is necessary to run an engine in an enclosed area, route the exhaust fumes out of the area with an approved, leak proof exhaust pipe extension.

Remove Paint Before Welding or Heating

Hazardous fumes can be generated when paint is heated by welding, soldering or using a torch. To avoid potentially toxic fumes and dust, remove paint before heating.

- Remove paint a minimum of 100 mm (4 in.) from the area that will be affected by heat.
- If paint cannot be removed, wear an approved respirator.
- If you sand or grind paint, use an approved respirator.
- If you use solvent or paint stripper, remove stripper with soap and water before welding. Remove solvent or paint stripper containers from the area.
- Allow at least 15 minutes for fumes to disperse before welding or heating.

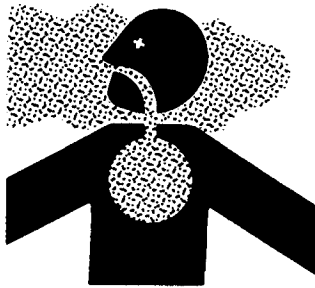

Do not use a chlorinated solvent in an area where welding will occur. Work only in areas that are well ventilated. Dispose of paint and solvent properly.

Service Cooling System Safely

Opening a pressurized cooling system can release explosive fluids and causing serious burns.

Before opening any pressurized cooling system, make sure the engine has been shut off. Do not remove a filler cap unless it is cool enough to comfortably grip with bare hands.



Slowly loosen cap to relieve pressure before opening fully.

Avoid High Pressure Fluids

Relieve pressure prior to disconnecting pressurized lines. Escaping fluid under pressure can penetrate the skin causing serious injury. Always relieve pressure before disconnecting hydraulic or other pressurized lines. Tighten all connections firmly before re-applying pressure.



If searching for leaks, use a piece of cardboard. Always protect your hands and other body parts from high-pressure fluids.

If an accident occurs, see a doctor immediately. Any high pressure spray injected into the skin must be removed within a few hours to prevent the risk of gangrene or other infection.

Avoid Heating Near Pressurized Fluid Lines

Flammable spray can be generated by heating near pressurized fluid lines, resulting in severe burns and bodily injury. Pressurized lines can rupture when heat goes beyond the immediate flame area. Do not weld, solder or use a torch or open flame near pressurized lines or other flammable fluids.

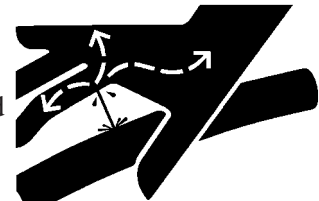

Do Not Open High-Pressure Fuel System

Many Northern Lights engines use high-pressure fuel injection. High-pressure fluid remaining in fuel lines can cause serious injury. Do not disconnect or attempt any repair of fuel lines, sensors, or other components between the high-pressure fuel pump and nozzles on engines with high pressure fuel systems.

ONLY AUTHORIZED TECHNICIANS CAN PERFORM REPAIRS ON AN HIGH PRESSURE FUEL INJECTION SYSTEMS.

Safety Rules (Continued)

Avoid Hot Exhaust

Avoid exposure to and physical contact with hot exhaust gases. Exhaust parts and streams can reach high temperatures during operation, leading to burns or other serious injury.

Cleaning exhaust filters can also lead to exposure to hot exhaust gas and the injury risk associated with it. Avoid exposure to and physical contact with hot exhaust gases when cleaning exhaust filters.



During auto or manual/stationary exhaust filter cleaning operations, the engine will run at elevated temperatures for an extended period of time. Exhaust parts and streams can reach high temperatures during operation, leading to burns or other serious injury.

Avoid Harmful Asbestos Dust

Inhaling asbestos fibers may cause lung cancer. Avoid breathing any dust that may be generated when handling components containing asbestos fibers, including some gaskets.

The asbestos used in these components is usually found in a resin or otherwise sealed.

Normal handling of these components is not dangerous, as long as airborne dust containing asbestos is not generated.

Avoid creating dust. Never use compressed air for cleaning. Avoid brushing or grinding materials containing asbestos. When servicing, wear an approved respirator. A special vacuum cleaner is recommended to clean asbestos. If this vacuum is not available, apply a mist of oil or water on the material containing asbestos. Keep all bystanders away from any area where asbestos dust may be generated.

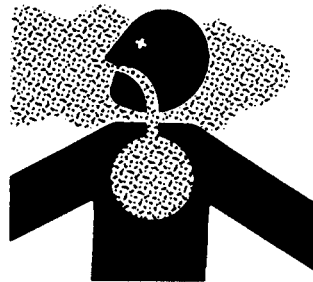

Use Proper Lifting Equipment and Techniques

Lifting heavy components incorrectly can cause severe injury or damage to machinery. Avoid unbalanced loads. Do not use lifting eyes. Lift the generator set using lifting bars inserted through the lifting holes on the skid. Follow all recommended removal and installation procedures in this and associated Northern Lights manuals.

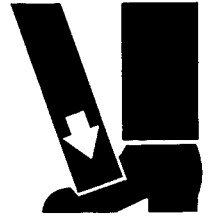

Use Proper Tools

Makeshift tools and procedures can create safety hazards. Always use appropriate tools for the job.



Use power tools only to loosen threaded parts and fasteners. For loosening and tightening hardware, always use the correct sized tools. Do not use US measurement tools on metric fasteners, or vice versa. Use only service parts that meet Northern Lights specifications.

Dispose of Waste Properly

Disposing of waste improperly can threaten the environment and lead to unsafe working conditions. Potentially harmful waste used in Northern Lights equipment can include oil, fuel, coolant, filters and batteries.

Use leakproof containers to drain fluid. Do not use food or beverage containers that may mislead someone into drinking from them.

Do not pour waste onto the ground, down a drain or into any water source.

Industrial Generator Component Locations

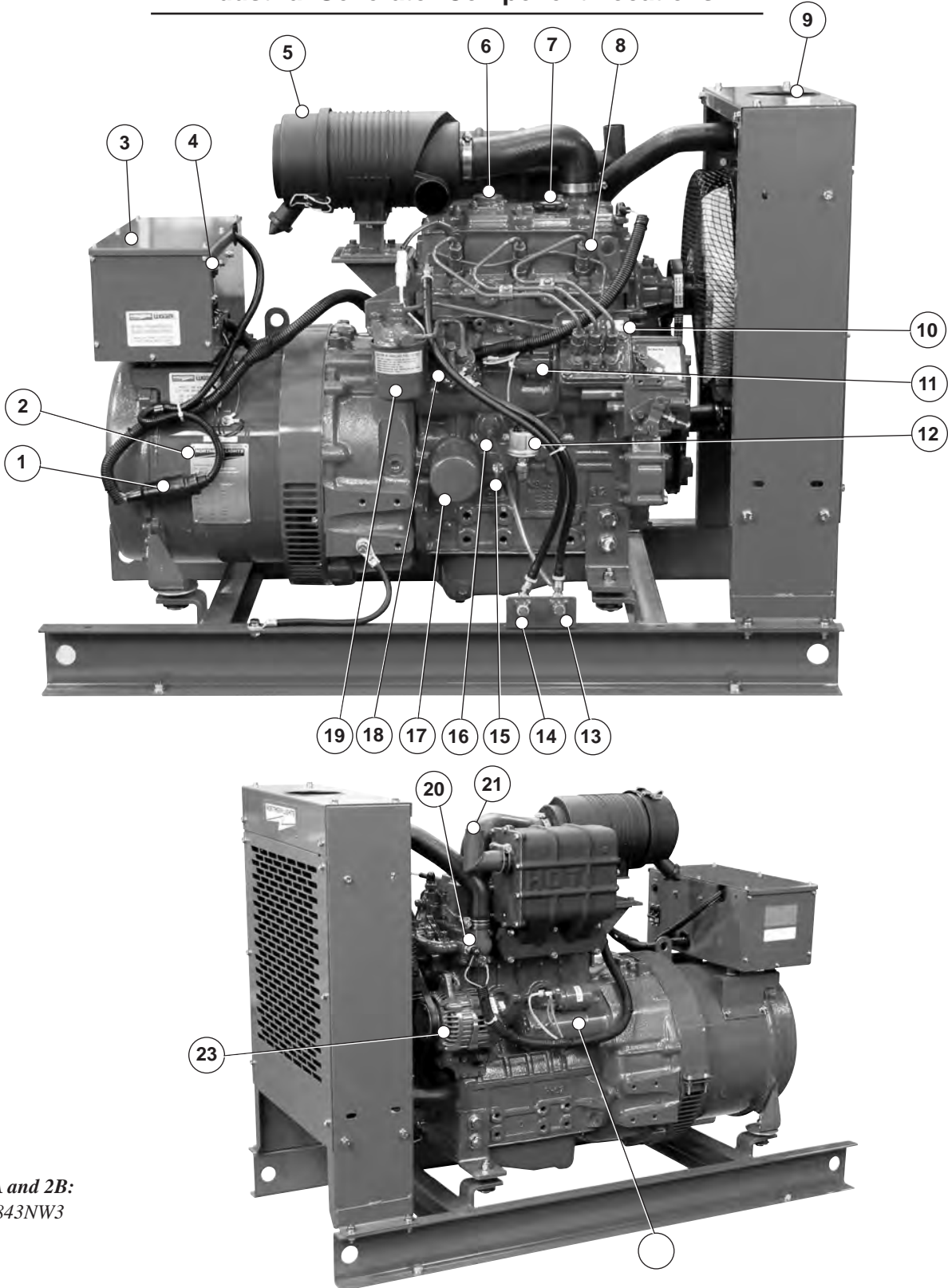

Figure 2A and 2B:
NL843NW3

- | | | | |
|---------------------------|-------------------------|----------------------|--------------------------------|
| 1. Control Panel Plug-in | 7. Oil Fill | 13. Fuel Inlet Line | 19. Fuel Filter |
| 2. Generator Plate | 8. Fuel Injector | 14. Fuel Return Line | 20. Coolant Temperature Sender |
| 3. Generator Junction Box | 9. Coolant Fill | 15. Oil Dipstick | 21. Exhaust Outlet |
| 4. DC Circuit Breaker | 10. Injection Pump | 16. Block Drain | 22. Starter |
| 5. Air Filter | 11. Shutdown Solenoid | 17. Oil Filter | 23. DC Alternator |
| 6. Crankcase Vent | 12. Oil Pressure Sender | 18. Fuel Lift Pump | |

Control Panels

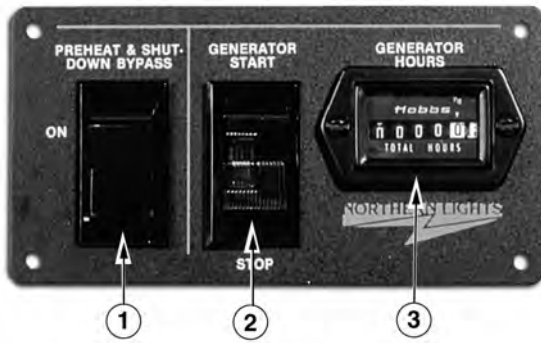

Figure 3-A: Series 1-B Generator Control Panel



Figure 3-B: Series 3 Generator Control Panel

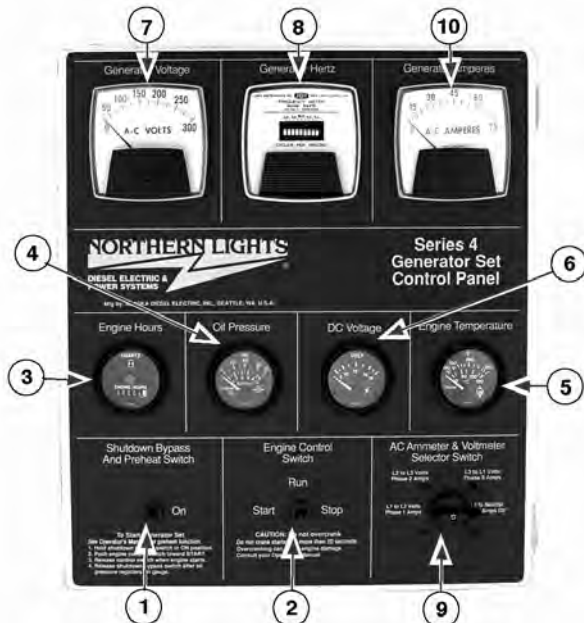

Figure 3-C: Series 4 Generator Control Panel

1. SHUTDOWN BYPASS-PREHEAT SWITCH

Two functions are built into this switch: the preheating of the engine, and bypassing of the engine safety shutdown circuit. Hold switch in the ON position 10 - 20 seconds before starting the engine, and continue holding on during engine cranking. Release the switch as soon as the engine is running. Holding the switch on too long can burn out the heater element.

2. ENGINE CONTROL SWITCH

To start the engine, hold this switch in the START position until the engine is running. After the engine starts, release the switch and it will return to RUN position. To stop the engine, hold the switch in the STOP position until the engine has completely stopped.

NOTE: The rocker switch is used on Series 1 panels only, and has a light that glows when the set is running.

3. HOUR METER

Keeps track of engine running time.

4. OIL PRESSURE GAUGE

Shows the oil pressure in the engine lubricating system.

5. ENGINE TEMPERATURE GAUGE

Registers the temperature of the engine coolant.

6. D.C. VOLTMETER OR AMMETER

When the engine is stopped, the voltmeter indicates the condition of the battery. When the engine is running, the voltmeter indicates the voltage output of the alternator.

For Series 4 Control Panels Only:

7. A.C. VOLTMETER

Shows the generator output voltage.

8. FREQUENCY METER (Hertz)

The frequency meter indicates alternating current frequency: 60 Hz (1800 RPM), or 50 Hz (1500 RPM).

9. AMMETER/VOLTMETER SELECTOR SWITCH

Used to check voltage and current of each phase.

10. A.C. AMMETER

Shows the generator load on each phase. The phase is selected with the Ammeter Selector switch (Item 9).

Operating Procedures

BREAK-IN PERIOD

1. The first 100 hours on a new or reconditioned engine are critical to its life and performance.
2. Frequently check the engine temperature and oil pressure gauges (sets with Series 3 or 4 panels).
3. Oil consumption is greater during break-in as piston rings take time to seat.
4. Break-In Oil Changes: Change engine oil and filter at 50 hours. Change oil and filter again at 100 hours (consult Lubricants section for oil recommendation), then every 250 hours.

Operating Instructions:

Maintain at least a 75% load on your generator set for the first 100 hours. If this is not possible, maintain no less than a 50% load to ensure proper seating of the piston rings. Vary the load to help seat the rings.

BEFORE STARTING

1. Check the water level by removing the pressure cap from the radiator. In order to give the cooling water an opportunity to expand, the level should be about 1 in. (2.5 cm) below the filler cap sealing surface when the engine is cold.



CAUTION: Use protective clothing and open the filler cap carefully when the engine is warm to prevent burns.

2. Check the oil level in the crankcase with the dipstick. The oil level must be in the waffled area on the stick. Never allow the level to go below this area. Always add the same viscosity of oil as is already in the crankcase.
3. Check the fuel tank level and open any fuel valves.
4. **NOTE:** The battery switch must always be kept ON while the engine is running. If the switch is turned OFF while the engine is running, the battery charging regulator could be damaged.

STARTING

1. Hold the Shutdown Bypass-Preheat switch in the ON position for about 10 seconds before starting a cold engine. Holding the switch too long can burn out the glow plugs.
2. While holding the Shutdown Bypass-Preheat switch in the ON position, push the Engine Control switch to the START position.
3. As soon as the engine starts, release both switches. Do not crank the starter for more than 10 seconds consecutively. If the engine fails to start with the first attempt, be sure that it has stopped completely before re-engaging.

OPERATING

1. Units with Series 3 and Series 4 Control Panels: check gauges often. Oil pressure must be above 15 PSI. The D.C. voltmeter should read between 11 and 15 volts at 80°F (25°C) ambient temperature. Check the A.C. voltage and frequency meters (Series 4 panel). If the gauges deviate from normal levels, shut down the generator set and investigate.
2. Let the unit run unloaded for a two to three minute warm-up period.
3. Apply electrical load.

STOPPING

1. Remove electrical load from the generator set.
2. Run the engine for a 3 to 5 minute cool down period.
3. Hold the Engine Control switch to the STOP position until the engine comes to a complete stop.

Operating Procedures

SHUTDOWNS AND ALARMS

1. Your unit is fitted with a system to protect it from high water temperature or low oil pressure.
 - a. Generator sets have shutdown systems to stop the engine. They have no warning horns.
 - b. Other alarms and shutdowns are available as optional equipment.

NOTE: Do not rely on your warning to the exclusion of careful gauge monitoring. Watching your gauges can prevent damage to the unit and dangerous power losses.

2. Do the following when your warning or shutdown system is activated:
 - a. Check the temperature gauge. If above 205°F (96°C), remove the load and then shut off the engine.
 - b. Use the Trouble Shooting Guide on page 22 to isolate the cause of the overheat.

 ***CAUTION: Do not remove the water fill cap of an overheated engine. Escaping high temperature steam can cause severe burns. Allow the engine to cool and then remove the cap slowly using protective clothing.***

- d. Make repairs. Restart your set after the temperature gauge registers below 200°F (94°C).
 - e. Watch the temperature gauge regularly and turn off the unit if the temperature rises above 205°F (96°C). Repeat troubleshooting.
3. If shutdown is activated and the temperature gauge shows temperature within normal temperature range:
 - a. Check the engine crankcase oil level.
 - b. If the oil level is low, fill with recommended lubricating oil and restart. Watch the oil pressure gauge carefully and shut off the engine if it does not show a normal reading (20-60 PSI) after a few seconds of operation.
 - c. If the oil level is normal, DO NOT restart the engine. Call your dealer for assistance.

SPARE PARTS

1. Northern Lights recommends that you keep the following spare parts on hand for field service. The parts are available from your local Northern Lights dealer.
2. All owners should have the following spares:
 - a. Primary and secondary fuel filter elements
 - b. Oil filters
 - c. Air filter
 - d. Alternator belt
 - e. Thermostat and gaskets
 - f. Glow plug
 - g. Injector and washer
3. If your set is operating a long distance from a servicing dealer, add the following:
 - a. Complete set of injectors
 - b. Copper washers for injector change
 - c. Complete set of glow plugs
 - d. Fuel lift pump

Servicing Schedule Chart

The Servicing Schedule Chart below shows the service schedule required for proper maintenance of your generator set. More detailed coverage of each Service Point (SP) is listed on the page noted in the 'page' column.

DAILY:

- SP1 Check oil level in engine
- SP5 Check V-belt tension
- SP7 Check primary fuel filter
- SP13 Check coolant level
- SP18 Check electrolyte in batteries

AFTER FIRST 50 HOURS:

- SP2/3 Change engine oil and filter
- SP6 Adjust valves

AFTER FIRST 100 HOURS:

- SP2/3 Change engine oil and filter

EVERY 250 HOURS:

- SP2/3 Change engine oil and filter
- SP4 Check air cleaner
- SP15 Check and clean radiator
- SP22 Inspect condition of exhaust system
- SP19 Check state of charge of batteries

EVERY 500 HOURS:

- SP8 Change primary fuel filter element
- SP9 Change secondary fuel filter

EVERY 1000 HOURS:

- SP6 Check valve clearances
- SP11 Check injectors

EVERY 2500 HOURS:

- SP12 Check fuel injection pump
- SP14 Check and flush cooling system

SERVICE POINT	PAGE	OPERATION	DAILY	50 Hours	250 Hours	500 Hours	1000 Hours	2500 Hours
		ENGINE:						
SP1	12	Check oil level	•					
SP2	12	Change engine oil 1) 5)		•	•			
SP3	12	Change lube oil filters 1) 5)		•	•			
SP4	13	Check air cleaner, change element @ 1000 hrs. 1) 4)			•			
SP5	13	Check V-belt tension	•					
SP6	13	Check valve clearances 1) 2)					•	
		FUEL SYSTEM:						
SP7	14	Check primary filter (Racor) 2) 3)	•					
SP8	14	Change primary filter element (Racor) 2) 3)				•		
SP9	14	Change secondary fuel filter 1) 3)				•		
SP10	15	Bleed the fuel system 3)						
SP11	17	Check injectors 1) 3) 6) 7)					•	
SP12	17	Check fuel injection pump 7)						•
		COOLING SYSTEM:						
SP13	17	Check coolant level	•					
SP14	18	Check and flush cooling system						•
SP15	18	Check and clean radiator fins			•			
		ELECTRICAL SYSTEM:						
SP18	19	Check electrolyte level in batteries	•					
SP19	19	Check condition of batteries with hydrometer 1) 4)			•			
		OUT OF SERVICE:						
SP21	19	Winterizing or out-of-service 3)						

- 1) Perform all maintenance once a year even if hour level has not been reached.
- 2) Consult manufacturer's maintenance schedule, note on chart.
- 3) Whenever necessary.
- 4) More often if necessary.
- 5) After first 50 hours, then after first 100 hours, then every 250 hours.

- 6) Clean injection nozzles every 1500 hours.
- 7) **For EPA emission standards fuel nozzle needs to be cleaned every 1500 hours, the fuel nozzle and fuel pump need to be cleaned, adjusted, or repaired every 3000 hours, and the quality guarantee for these parts is 1500 hours or 2 years.**

Service Record Notes

Servicing

LUBRICATION - GENERAL

1. Use only clean, high quality lubricants stored in clean containers in a protected area.
2. These lubricants are acceptable:
 - a. API Service CC/CD/CE single viscosity oils.
 - b. API Service CC/CD/SF multi-viscosity oils.
3. Use the proper weight oil for your average operation temperature.

Air Temperature	Single Viscosity	Multi-Viscosity
Above 32°F (0°C)	SAE 30W	SAE 15-40W
-10 to 32°F (-23 to 0°C)	SAE 10W	SAE 10-30W
Below -10°F (-23°C)	SAE 5W	SAE 5-20W

Figure 4: Lube Oils

4. Some increase in oil consumption may be expected when SAE 5W and SAE 5-20W oils are used. Check oil level frequently.
5. Never put additives or flushing oil in crankcase.

SP1. CHECKING OIL LEVEL

1. Check the oil level in the crankcase with the dipstick. The oil level must be in the waffled area on the stick. Never allow the level to go below this area. Follow the lubrication recommendations above.

SP2. OIL CHANGES

1. The set is delivered with special break-in oil. Change the engine oil and oil filter after 50 hours of operation. Use Service CC 30 weight oil during the first 100 hours.
2. Change the oil and filter again at 100 hours using the oil recommended in the above diagram. After this, change oil and filter every 250 hours.
3. During intermittent cold weather operation, change oil every 100 hours or six weeks, whichever comes first.
4. Change oil at the end of each season and the beginning of each season.
5. Change oil when engine is warm.
6. Dispose of waste oil in an approved manner.
7. Never use a flushing oil.
8. Loosen the clamp on the oil change tube. Remove cap. Drain oil. Replace the cap and tube.
9. Refill engine with recommended oil for the season.
10. Engine capacity with new oil filter is:
NL843NW3 – 1.6 gallons (6 liters)

SP3. CHANGING LUBE OIL FILTER

1. Change the lube oil filter every 250 hours.
2. Use a filter wrench to remove old filter. Dispose of filter in approved manner.
3. Make sure the gasket from the old filter is removed and discarded. Clean mount face.
4. Spread a thin film of engine oil on the rubber gasket on the new filter and screw it on nipple until gasket meets the sealing surface.
5. Using hands only – no wrench – tighten filter one-half turn farther. Overtightening can do damage to filter housing.
6. Fill engine with recommended oil. Start engine and check for leakage. Stop engine, wait 3 minutes, and check oil level. Add additional oil if necessary.
7. Oil filter part number is:
NL843NW3 – #24-03100

Servicing

SP4. AIR CLEANER

1. Inspect air cleaner every 250 hours. In dusty conditions, check more often.
2. Replace if necessary. Part number is:
NL843NW3 (ELEMENT ONLY) – #24-27302
3. **NOTE: Make absolutely sure no impurities enter the engine while changing the element. Do NOT run the engine with the air cleaner removed.**

SP5. V-BELTS

1. Check the tension and wear on the V-belt daily.
2. Use your thumb to press on the belt at the midpoint between the crankshaft and alternator pulleys. The tension is correct if the belt can be depressed about 3/16 in. (5 mm). Fan belt slackness should be about 3/16 in. (5 mm).
3. To adjust the belt tension loosen the alternator adjusting plate bolt and the alternator mounting bolt. Pivot the alternator at the mounting bolt as needed.
4. Tighten the mounting bolt and the adjusting bolt.
5. Operate engine at low idle speed and recheck the belt tension.

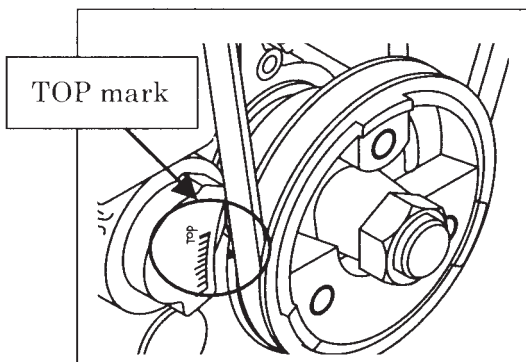

Figure 5: Timing mark

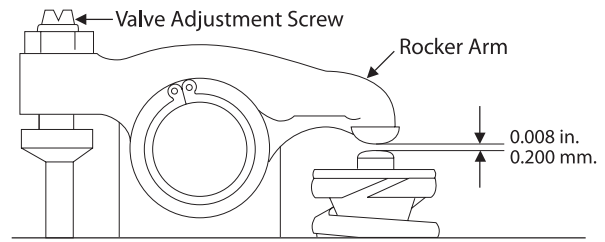

Figure 6: Valve Adjustment

SP6. VALVE CLEARANCES

1. Adjust valve clearance after the first and then at 1000 hours, or as needed.
2. Engine should be cold and NOT running.
3. Watch the valves while turning the engine over by hand. Turn until the inlet valve starts to open and the exhaust valve starts to close (the valves are rocking). Then turn the crankshaft one more full turn and adjust the clearance on both valves for this cylinder. Align the top mark of the crank pulley with the TOP mark of the timing gear case.
4. Loosen the lock nut and adjust the clearance between the rocker arm and valve guide of both the intake and exhaust valves with the adjustment screw (Figure 6). Clearance on both intake and exhaust valves should be 0.008 in. (0.2 mm).
5. Repeat steps 3 and 4 for each cylinder. Each set of valves must be adjusted individually.
6. Replace the rocker arm cover. Tighten cover nuts to 5 - 8 ft/lbs (0.8 - 2.3 kg/m).

Cylinder	No. 1		No. 2		No. 3	
	In	Ex	In	Ex	In	Ex
Valve Arrangement						
When No. 1 cyl. is at TDC in compression stroke	○	○		○		
With the crankshaft turned by 360° in normal direction from above			○		○	○

Figure 7: 843NW3 Valve sequence

Servicing

FUELS - GENERAL

1. Use only clean, high quality fuels of the following specifications, as defined by ASTM designation D975 for diesel fuels:
 - a. Use grade no. 2 diesel at ambient temperatures above freezing 32°F (0°C).
 - b. Use grade no. 1 at ambient temperatures below freezing and for all temperatures at an altitude of above 5,500 ft. (1500 meters).
2. Use fuel having less than 1% sulphur (preferably less than 0.5%).
3. The cetane number should be a minimum of 45.
4. DO NOT use these unsuitable grades of fuel:
 - a. Domestic heating oils, all types.
 - b. Class B engine.
 - c. Class D domestic fuels.
 - d. Class E, F, G or H industrial or marine fuels.
 - e. ASTM-D975-60T No. 4-D and higher number fuels.
5. Storing fuel:
 - a. Keep dirt, scale, water, and other foreign matter out of fuel.
 - b. Avoid storing fuel for long periods of time.
 - c. Fill the fuel tank at the end of each day's operation. This will reduce condensation and possible biological contamination.
 - d. If biological contamination is detected or suspected, contact your dealer for assistance.
6. Biodiesel:

Biodiesel involves the transesterification of vegetable oils or animal fats. It can involve animal fats, yellow greases (used greases), cotton seed, sunflower seed, coconut oil, or sesame seed, but mainly in the US soybean methyl ester is used (SME). In Europe mainly rapeseed (canola) methyl ester is made (RME), and in Asia palm methyl ester (PME) is made. 100% biodiesel (B100) is made in compliance with ASTM D6751 or EN14214 (EU) specifications.

Biodiesel may be used in a 5% blend (5% biodiesel/ 95% diesel) from a BQ-9000 accredited producer. 20% biodiesel blends (20% biodiesel/ 80% diesel) can only be used if they meet ASTM D6751 or EN14214 (EU) specifications. A 2% reduction in power and a 3% reduction in fuel economy can be expected if a 20% blend is used. With a 20% biodiesel blend, an approved fuel conditioner is recommended. The petroleum part of the biodiesel blend must meet ASTM D975 or EN590

(EU) specifications. Biodiesel blends must be used within 90 days of their manufacture. When biodiesel blends are used the oil level must be checked daily and storage, leaking, possible microbial growth, plugging, and components degradation must all be checked more frequently.

Note: Using raw pressed or partially refined vegetable oils or recycled greases as fuel (which have not been through transesterification) could cause engine failure.

Request a certificate of analysis from an approved biodiesel fuel distributor to make sure the biodiesel blend meets specifications.

SP7-9. FUEL FILTERS



Figure 8: Primary Fuel Filter (if provided by Northern Lights)

1. Your generator set may have a primary fuel filter installed. We recommend the Racor brand of fuel filter-water separators.
 - a. Check the primary fuel filter daily as recommended by the filter manufacturer. Empty the collection bowl as necessary.
 - b. Change the element as often as necessary or every 500 hours.
 - c. If the bowl fills with water, change the primary and secondary element immediately.
2. Change secondary fuel filter every 500 hours.

NOTE: The fuel filter on the engine is considered the "secondary fuel filter."

 - a. Remove the spin-on filter by turning it counterclockwise with a filter wrench. Fill the new cartridge with fuel and install it after applying engine oil to gasket surface. Screw on until the gasket surface comes into contact with sealing surface of filter base. Then, tighten it two-thirds of a turn by hand. Do not overtighten.
 - b. Secondary fuel filter cartridge part number is:
NL843NW3 - #24-52020

Servicing

SP10. BLEEDING THE FUEL SYSTEM



CAUTION: Escaping diesel fuel under pressure can penetrate skin causing serious personal injury. Before disconnecting lines be sure to relieve all pressure. Before applying pressure, be sure all connections are tight and lines, pipes and hoses are not damaged. Fuel escaping from a very small hole can be almost invisible. Use a piece of cardboard or wood, rather than hands, to search for suspected leaks. If injured by escaping fuel, see a doctor at once. Serious infection or reaction can develop if proper medical treatment is not administered immediately.

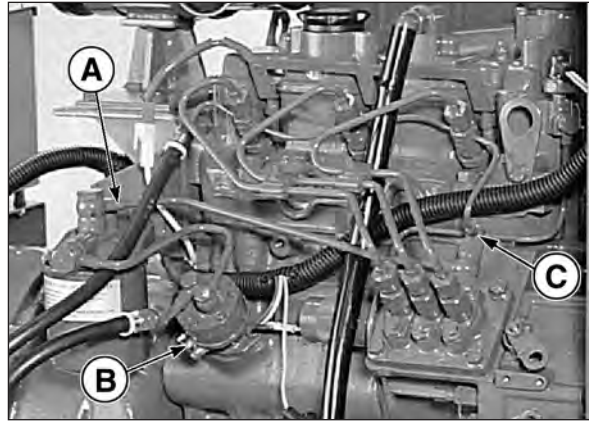

Figure 9: NL843NW3 Fuel System (for illustration purposes).

1. The fuel system is self-bleeding. However, any system may need manual bleeding when:
 - a. A new fuel filter is installed;
 - b. The engine has run out of fuel;
 - c. The fuel lines, injection pump or any other fuel system component has been removed and installed.
2. Loosen bleed bolt "A" (Figure 9) on top of the filter. Pump hand primer "B" on fuel lift pump until pure fuel (no bubbles) escapes from bleed bolt "A". Tighten bleed screw "A".
3. Loosen bleed screw "C". Pump hand primer "B" until pure fuel (no bubbles) escapes. Then tighten bleed screw "C".
4. If the engine does not start after the above bleeding process, loosen a fuel line at the injector while cranking the engine with the starter motor until pure fuel escapes. Then tighten the connection. Do each line **one-at-a-time**.
5. After the engine has started, use a piece of cardboard to look for fuel leaks.

Servicing

Figures 10-17: For illustrative purposes only, may not be exact model.



Figure 10: Remove delivery line flare nuts.



Figure 14: Remove return line.

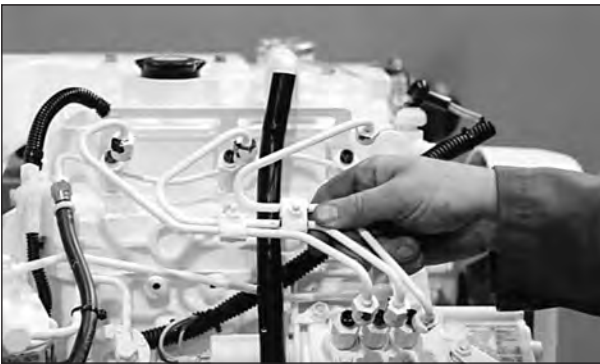

Figure 11: Remove delivery lines.



Figure 15: Unscrew injector.



Figure 12: Cover lines, inlets and injection pump outlets.



Figure 16: Remove and replace copper sealing washer.

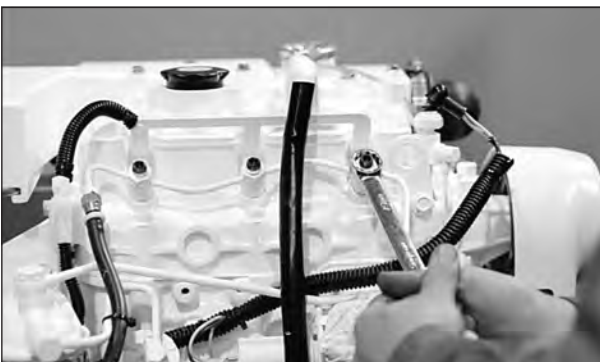

Figure 13: Remove return line nuts.



Figure 17: Reinstall injector. Torque to proper tightness.

Servicing

SP11. INJECTOR SERVICE

1. Injectors should be checked every 1000 hours. Check should be made by a Northern Lights dealer or local injection repair station.



CAUTION: *Escaping diesel fuel under pressure can have sufficient force to penetrate the skin causing serious personal injury. If injured by escaping diesel fuel, see a doctor at once.*

2. Injector removal:

- a. Clean loose dirt from around the injectors and the fuel lines.
- b. Relieve high pressure in the fuel lines by loosening the delivery line flare nuts at each injector (Figure 8).
- c. Remove delivery lines by disconnecting from injectors and injection pump (Figure 9). Remove all lines as an assembly; do not remove the spacers. Cover the ends of the lines, the injector inlets and injection pump outlets to keep dirt out.
- d. Remove the return line retaining bolts (Figure 10). Remove the return line (Figure 11).
- e. Unscrew and remove the injectors (Figure 12).
NOTE: *Do not use pry bars to remove injectors from cylinder head.*
- f. After removing the injectors, discard the copper sealing washers from the injector hole in the head (Figure 13). Cover holes to prevent dirt and debris from entering the cylinders.

3. Injector installation:

- a. Install a new copper sealing washer in each injector hole (Figure 13).
- b. Screw in injector and tighten to 43 or 50 ft/lbs (6 to 7 kgm) (Figure 14).
NOTE: *Overtightening can damage injector.*
- c. Install return line using new copper sealing above and below each connection. Tighten return line retaining bolts to 22 - 30 ft/lbs.
- d. Install delivery lines. Leave loose at injectors for bleeding.
- e. Pump hand level on fuel pump to fill lines. Tighten lines at injectors. Start engine and check for leaks using a piece of paper or cardboard.
DO NOT use hand to check for leaks.

SP12. INJECTION PUMP

1. Since operating conditions may vary considerably, it is difficult to give a definite interval for checking the injection pump. But as a rule, pump settings, maximum speed, idle speed and exhaust smoke should be checked after every 2500 hours of operation. Service of the fuel injection pump should only be done if checks indicate pump malfunction.
2. Black smoke can be an indication of pump malfunction. Before servicing the pump, check other possible causes:
 - a. Check cleanliness of air filter.
 - b. Check valve clearances.
 - c. Clean and check injectors.
3. Any repair which involves disassembly of the injection pump must be carried out by specially trained mechanics with the proper tools and test equipment.

NOTE: *All warranties on the engine become null and void if the injection pump seals are broken by unauthorized persons.*

COOLING SYSTEM - GENERAL



CAUTION: *The cooling water in the engine reaches extremely high temperatures. You must use extreme caution when working on hot engines to avoid burns. Allow the engine to cool before working on the cooling system. Open the filler cap carefully, using protective clothing when the engine is warm.*

WATER QUALITY

1. Distilled, deionized, soft water is preferred for use in cooling systems. Bottled distilled water from a food store or water supplier is recommended. Tap water often has a high mineral content. Tap water should NEVER be put in a cooling system unless first tested by a water quality laboratory. Do not use water made by the reverse osmosis method unless it has been PH neutralized.

Servicing

2. Here are acceptable water quality specifications:

Contaminates	Parts per Million	Grains per Gallon
Maximum Chlorides	40	2.5
Maximum Sulfates	100	5.9
Maximum Dissolved Solids	340	20.0
Maximum Total Hardness	170	10.0
PH Level 5.5 to 9.0		

3. If chlorides, sulfates or total dissolved solids are higher than the above given specification, the water must be distilled, demineralized, or deionized before it is used in a cooling system.
4. If total hardness is higher than 170 ppm and all other parameters are within the given specifications, the water must be softened before it is used to make coolant solution.

SP13. CHECK THE COOLANT LEVEL

1. Check the coolant level each day before starting the engine. Check the water level by removing the pressure cap from the radiator.
In order to give the cooling water an opportunity to expand, the level should be about 1 in. (2.5 cm) below the filler cap sealing surface when the engine is cold.
2. The pressure valve in the filler cap releases when the pressure is approximately 7 PSI (0.5 bar). Use a cap pressure tester to check cap if you suspect it is faulty.

SP14. COOLING SYSTEM FLUSHING

1. Flush the cooling system every 2500 hours or every 12 months, whichever comes first.
2. Industrial sets:
 - a. Remove radiator cap and open radiator drain and drain engine block.
 - b. Pour clean water into radiator until water coming from radiator is free of discoloration and sediment.
 - c. Close the radiator drain and continue flushing until water from the engine drain is clear.
 - d. Open all drain cocks and drain completely.
 - e. Close drain cocks and refill with recommended coolant.
 - f. Clean leaves, dust, and other debris off the

radiator fins.

3. Coolant Specifications:
Use 50% distilled water / 50% ethylene glycol anti-freeze mix. Antifreeze mixture is recommended as a good year-round coolant.
4. Check hoses and connections and repair any leakage.

SP15. CLEAN RADIATOR

1. Remove debris from radiator fins daily.
2. In very dusty applications, clean the radiator with compressed air or steam cleaner every 100 hours. and check for leaks.

GENERATOR ENDS

The maintenance and operation recommendations for the generator end are in a separate Owner's Manual. If you do not have one of these manuals, contact your local Northern Lights dealer.

ELECTRICAL SYSTEM - GENERAL

1. Never switch battery switch off or break the circuit between the alternator and batteries while the engine is running. Alternator damage can result.
2. Do NOT reverse the polarity of battery cables when installing the battery.
3. If welding on the unit, disconnect the regulator and battery. Isolate the leads.
4. Disconnect the battery cables when servicing the D.C. alternator.
5. Never test with a screwdriver, etc., against any terminal to see if it emits sparks.
6. Do not polarize the alternator or regulator.
7. The D.C. circuit breaker protects your control panel and wiring harness. It is located in the side of the generator junction box.

GLOW PLUGS

1. Each cylinder is supplied with a glow plug which serves to heat the combustion chamber.
2. To check the glow plugs, loosen the current carrying flat wire between the plus-poles of the glow plugs (Figure 18). Connect a D.C. test bulb between the plus-pole of the battery and the plus-pole of the glow plug. If the bulb lights up, the glow plug is functioning properly.

Servicing

SP 18-19. BATTERY CARE

3. Check all glow plugs and replace any faulty ones.

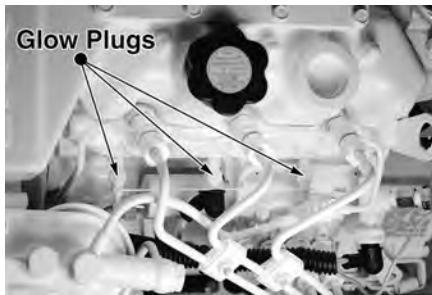

Figure 18: Glow plugs.

BOOSTER BATTERIES



CAUTION: *Battery gas can explode. Keep all flames and sparks away from batteries.*

1. Before changing or using booster batteries, check battery electrolyte level. Add distilled water if necessary.
2. Booster and main batteries must have the same voltage rating.
3. First, connect positive (+) terminal of booster battery to positive (+) terminal of main battery. Then, connect negative (-) terminal of booster battery to ground on the engine block (see Figure 19).
4. Remove booster battery after starting engine.
5. Sealed batteries: See manufacturer charging and booster instructions.

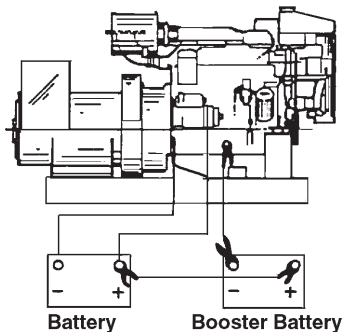

*Figure 19:
Battery connections.*

1. Check electrolyte level daily. Add distilled water to manufacturer's recommended level.
2. Batteries, cables and cable terminals should be checked and cleaned every 100 hours. Clean corrosion with a water and baking soda solution. Flush with clean water. Tighten terminals and grease them to inhibit corrosion.
3. Check the battery condition with a hydrometer every 250 hours.

SP21. WINTERIZING / OUT-OF-SERVICE

1. Industrial sets:
 - a. Drain and flush the radiator and cooling system. Refill with antifreeze-water mixture. Start the engine and run to circulate the antifreeze.
 - b. Fill the fuel tank or add biocide as per the manufacturer's instructions.
 - c. Change the crankcase oil and filter.
 - d. Seal the air cleaner inlet, exhaust opening, crankcase breather pipe, and fuel tank vent with plastic bags and tape.
 - e. Loosen the alternator belt.
 - f. Disconnect and clean battery. Remove to warm storage place if possible.
 - g. Clean outside of unit. Paint any scratched or chipped surfaces. Put corrosion preventative on all exposed metal surfaces.
 - h. Store the set in a dry, protected place. If the unit must be stored outside, be sure it is well protected with a cover.

Troubleshooting

DC ELECTRICAL SYSTEM

PROBLEM	POSSIBLE CAUSE	RECOMMENDATION(S)
Battery Will Not Charge	Loose or corroded connections	• Clean and tighten battery connections.
	Sulfated or worn out batteries	• Check specific gravity of each battery. • Check electrolyte level of each battery.
	Loose or defective alternator belt	• Adjust belt tension. • Replace belt.
Starter Inoperative	Check DC circuit breaker	• If the breaker is tripped, reset it.
	Loose or corroded connections	• Clean and tighten loose battery and harness plug connection.
	Low battery output	• Check specific gravity of each battery. • Check electrolyte level of each battery.
	Defective electrical system ground wire:	• Repair or replace.
Starter Cranks Slowly	Low battery output	• Battery is too small. • Battery cables are too small.
	Check specific gravity of each battery	• Replace battery if necessary.
	Check electrolyte level of each battery	• If low, fill cells with distilled water.
	Crankcase oil too heavy	• Fill with oil of appropriate viscosity.
	Loose or corroded connections	• Clean and tighten loose connections.
Entire Electrical System Does Not Function	Check DC circuit breaker	• If breaker is tripped, reset it.
	Faulty connection	• Clean and tighten battery and harness plug connections.
	Sulfated or worn out batteries	• Check specific gravity and electrolyte level of each battery.

If you cannot correct problems with these procedures, see your **Northern Lights** dealer.

Troubleshooting

ENGINE

PROBLEM	POSSIBLE CAUSE	RECOMMENDATION(S)
Engine Hard to Start or Will Not Start	Improper starting procedure	<ul style="list-style-type: none"> • See starting section of this manual. Take special note of Bypass Switch operation.
	No fuel	<ul style="list-style-type: none"> • Check level of fuel in fuel tank.
	Low battery output	<ul style="list-style-type: none"> • Check electrolyte level and condition.
	Excessive resistance in starting circuit	<ul style="list-style-type: none"> • Clean and tighten all battery connections.
	Crankcase oil too heavy	<ul style="list-style-type: none"> • Use oil of proper viscosity.
	Improper type of fuel	<ul style="list-style-type: none"> • Consult fuel supplier and use proper type of fuel for operating condition.
	Water, dirt or air in fuel system	<ul style="list-style-type: none"> • Drain, flush, fill and bleed system.
	Clogged primary fuel filter element	<ul style="list-style-type: none"> • Clean or replace filter element.
	Clogged secondary fuel filter element	<ul style="list-style-type: none"> • Replace filter element.
Engine Runs Irregularly or Stalls Frequently	Dirty or faulty injection nozzles	<ul style="list-style-type: none"> • Have your dealer check injection nozzles.
	Below normal engine temperature	<ul style="list-style-type: none"> • Remove and check thermostat.
	Clogged primary fuel filter element	<ul style="list-style-type: none"> • Clean or replace filter element.
	Clogged secondary fuel filter element	<ul style="list-style-type: none"> • Replace secondary filter element.
	Water or dirt in the fuel system	<ul style="list-style-type: none"> • Drain, flush, fill and bleed system.
	Dirty or faulty injection nozzles	<ul style="list-style-type: none"> • Have your dealer check injection nozzles.
	Air in fuel system	<ul style="list-style-type: none"> • Inspect clamps and hoses on suction side of fuel pump for air leak.
Improper type of fuel	<ul style="list-style-type: none"> • Consult fuel supplier and use proper type of fuel for operating condition. 	
Lack of Engine Power	Intake air restriction	<ul style="list-style-type: none"> • Service air cleaner.
	Clogged primary fuel filter element	<ul style="list-style-type: none"> • Clean or replace filter element.
	Clogged secondary fuel filter element	<ul style="list-style-type: none"> • Replace filter element.
	Improper type of fuel	<ul style="list-style-type: none"> • Consult fuel supplier and use proper type of fuel for operating conditions.
	Overheated engine	<ul style="list-style-type: none"> • See “Engine Overheats” in next category.
	Below normal engine temperature	<ul style="list-style-type: none"> • Remove and check thermostat.
	Improper valve clearance	<ul style="list-style-type: none"> • Reset valves. Best done by dealer.
	Dirty or faulty injection nozzles	<ul style="list-style-type: none"> • Replace injectors. Best done by dealer. • See your local dealer.

Troubleshooting

ENGINE

PROBLEM	POSSIBLE CAUSE	RECOMMENDATION(S)
Engine Overheats	Low coolant level	<ul style="list-style-type: none"> • Fill tank or radiator to proper level. • Check hoses for loose connections and leaks.
	Cooling system needs flushing	<ul style="list-style-type: none"> • Flush cooling system.
	Defective thermostat	<ul style="list-style-type: none"> • Remove and check thermostat.
	Defective temperature gauge	<ul style="list-style-type: none"> • Check water temperature with thermometer and replace gauge if necessary.
Engine Knocks	Insufficient oil	<ul style="list-style-type: none"> • Call your dealer.
	Injection pump out of time	<ul style="list-style-type: none"> • Call your dealer.
	Below normal engine temperature	<ul style="list-style-type: none"> • Check your thermostats. • Check water temperature to see if temperature gauge is working properly.
	Engine overheating	<ul style="list-style-type: none"> • See “Engine Overheating” section.
High Fuel Consumption	Improper type of fuel	<ul style="list-style-type: none"> • Use correct fuel for temperature.
	Clogged or dirty air cleaner	<ul style="list-style-type: none"> • Service air cleaner.
	Improper valve clearance	<ul style="list-style-type: none"> • See your dealer.
	Injection nozzles dirty	<ul style="list-style-type: none"> • See your dealer.
	Injection pump out of time	<ul style="list-style-type: none"> • See your dealer.
	Engine not at proper temperature	<ul style="list-style-type: none"> • Check your thermostats. • Check water temperature with thermometer and replace gauge if necessary.
Below Normal Engine Temperature	Thermostat not working properly	<ul style="list-style-type: none"> • Check thermostat.
	Temperature gauge not working properly	<ul style="list-style-type: none"> • Check water temperature with thermometer.
Low Oil Pressure	Low oil level	<ul style="list-style-type: none"> • Fill crankcase to proper level.
	Improper type of oil	<ul style="list-style-type: none"> • Drain and fill crankcase with correct oil.
	Partially plugged oil filter	<ul style="list-style-type: none"> • Replace filter.
High Oil Consumption	Break-in period	<ul style="list-style-type: none"> • Oil consumption decreases after break in.
	Crankcase oil too light	<ul style="list-style-type: none"> • Use proper viscosity oil.
	Oil leaks	<ul style="list-style-type: none"> • Check for leaks in lines around gaskets and drain plug.

If you cannot correct problems with these procedures, see your **Northern Lights** dealer.

Troubleshooting

ENGINE

PROBLEM	POSSIBLE CAUSE	RECOMMENDATION(S)
Engine Emits Black or Gray Exhaust Smoke	Clogged or dirty air cleaner	• Service air cleaner.
	Defective muffler (back pressure too high)	• Have dealer check back pressure.
	Improper fuel	• Use correct fuel for temperature.
	Injection nozzles dirty	• See your dealer.
	Engine injectors timing off	• See your dealer.
Engine Emits White Smoke	Improper fuel	• Use correct fuel for temperature.
	Cold engine	• Warm up engine to normal operating temperature.
	Defective thermostat	• Remove and check thermostat.
	Injector timing wrong	• See your dealer.

If you cannot correct problems with these procedures, see your **Northern Lights** dealer.

NL843NW3 Data

NL843NW3		
Kilowatt Rating Prime Rated RPM/Frequency	12 kW 1800/ 60Hz	10 kW 1500/ 50 Hz
General Information		
Engine Type	Lugger 4 cycle, swirl chamber diesel	
Cylinders	Inline 3	
Displacement	91 in ³ (1.5 liters)	
Cycles	4	
Bore x Stroke	3.3 x 3.54 in (84 x 90 mm)	
Rotation (Facing Flywheel)	counter-clockwise	
Compression Ratio	22:5	
Crankcase Capacity including Oil Filter	1.6 gal (6.0 liter)	
Aspiration	Natural	
Rated Horsepower	20.1 Hp	16.6 Hp
Approximate Dry Weight	757 lbs. (343 kg)	
Length	43 in (1092 mm)	
Width	22 in (559 mm)	
Height	33.13 in (842 mm)	
Approx. Coolant Capacity	1.1 gal (4 liters)	
Approx. Coolant Capacity (engine only)	.74 gal (2.8 liters)	
Standard Output, Single Phase	120-240 Volts, 50 Amps	220 Volts, 45.2 Amps
Compression Pressure of Cylinder MPa (kgf/cm ²)	Standard Value: More than 2.94 MPa (more than 30 kgf/cm ²) Time to be repaired: Less than 2.45 MPa (less than 25 kgf/cm ²)	
Cylinder Head Tightening Torque N•m (kgf/cm ²)	98 - 103 N•m (10.0- 10.5 kgf/cm ²)	

Wiring Diagram

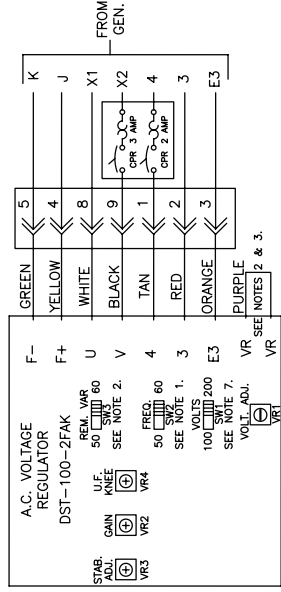
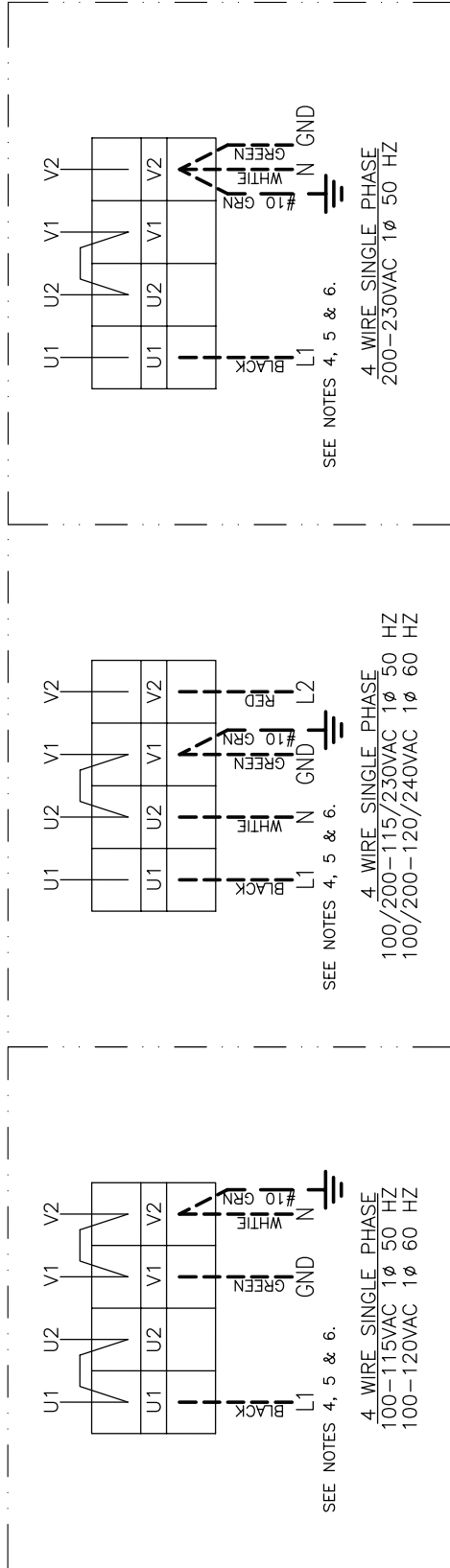

- NOTES:**
1. SET SW2 FOR CURRENT APPLICATION, (50 OR 60 HZ)
 2. SET SW3 PER APPLICATION IF REMOTE VOLTAGE ADJUST RHEOSTAT IS USED.
 3. FOR REMOTE VOLTAGE ADJUST RHEOSTAT CUT JUMPER AND 'SPICE INTO PURPLE LEADS.
 4. TERMINAL BLOCKS WILL NOT ACCOMMODATE LARGER GAUGE CONDUCTORS. IF REQUIRED, REMOVE AFFECTED LEADS FROM TERMINAL BLOCK(S) AND MAKE CONNECTIONS USING BOLT, LOCK WASHER AND NUT. ISOLATE BY WRAPPING WITH ELECTRICAL TAPE.
 5. MARINE GENSETS ARE GROUNDED BY CUSTOMER, AT CUSTOMER'S DISCRETION. INDUSTRIAL GENSETS ARE TO BE GROUNDED IN ACCORDANCE WITH THE NATIONAL ELECTRICAL CODE AND ANY APPLICABLE LOCAL CODES.
 6. HIDDEN (DASHED) LINES INDICATE CUSTOMER SUPPLIED AND CONNECTED MAIN OUTPUT CONDUCTORS. SIZING TO BE DETERMINED PER INSTALLATION.
 7. AVR INPUT SENSING SWITCH SW1 IS TO BE SET TO THE 200V POSITION FOR ALL VOLTAGES EXCEPT 100-120VAC APPLICATIONS.

AC Wiring Diagram
 12 & 4 Lead Generators, DST-100-2FAK AVR
 B-9724C

Wiring Diagram

- NOTES:**
1. ALL NLI INSTALLED CONDUCTORS ARE TO BE TYPE MTW, 105°C, STRANDED, 600VAC.
 2. SET SW2 FOR CURRENT APPLICATION, (50 OR 60 HZ.)
 3. SET SW2 PER APPLICATION IF RELAYE VOLTAGE ADJUST RHEOSTAT IS USED.
 4. SET SW2 PER APPLICATION IF RELAYE VOLTAGE ADJUST RHEOSTAT IS USED.
 5. SET SW2 PER APPLICATION IF RELAYE VOLTAGE ADJUST RHEOSTAT IS USED.
 6. MARINE GENSETS ARE GROUNDED BY CUSTOMER AT CUSTOMER'S DISCRETION. GENSETS ARE TO BE GROUNDED IN ACCORDANCE WITH THE NATIONAL ELECTRICAL CODE AND ANY APPLICABLE LOCAL CODES.
 7. THICK HIDDEN (DASHED) LINES INDICATE CUSTOMER SUPPLIED AND CONNECTED MAIN OUTPUT CONDUCTORS. SIZING TO BE DETERMINED PER INSTALLATION.
 8. NEUTRAL CONDUCTORS SIZED FOR 30KW UNITS AT THE LOWEST LISTED VOLTAGE. CONSULT N.L.I. ENGINEERING FOR CONDUCTOR SIZING AT OTHER GENSET VOLTAGE/RM RATINGS.
 9. THE DOUBLE DELTA CONFIGURATION REQUIRES THE AVR TO BE REWIRING AS FOLLOWS:
DISCONNECT LEAD 3 AND 4 FROM AVR. CONNECT LEAD 3 TO AVR TERM. 4 (THROUGH C.B.). CONNECT LEAD 4 TO AVR TERM. 3. DISCONNECT LEAD E3 FROM AVR AND ISOLATE. CONNECT AVR TERMINAL E3 TO MAIN OUTPUT BLOCK. USING A RED AVG. 14 LEAD WITH ARTICLE 215-8 OF THE NATIONAL ELECTRICAL CODE.
 10. LINE ONE (HIGH LEG) TO BE MARKED ORANGE WHEN NEUTRAL "N" IS PRESENT, IN ACCORDANCE WITH ARTICLE 215-8 OF THE NATIONAL ELECTRICAL CODE.
 11. AVR INPUT SENSING SWITCH SW1 IS TO BE SET TO THE 200V POSITION FOR ALL VOLTAGES EXCEPT 100-120VAC APPLICATIONS.

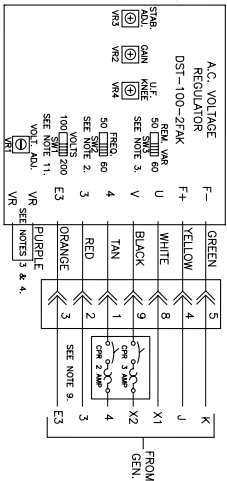
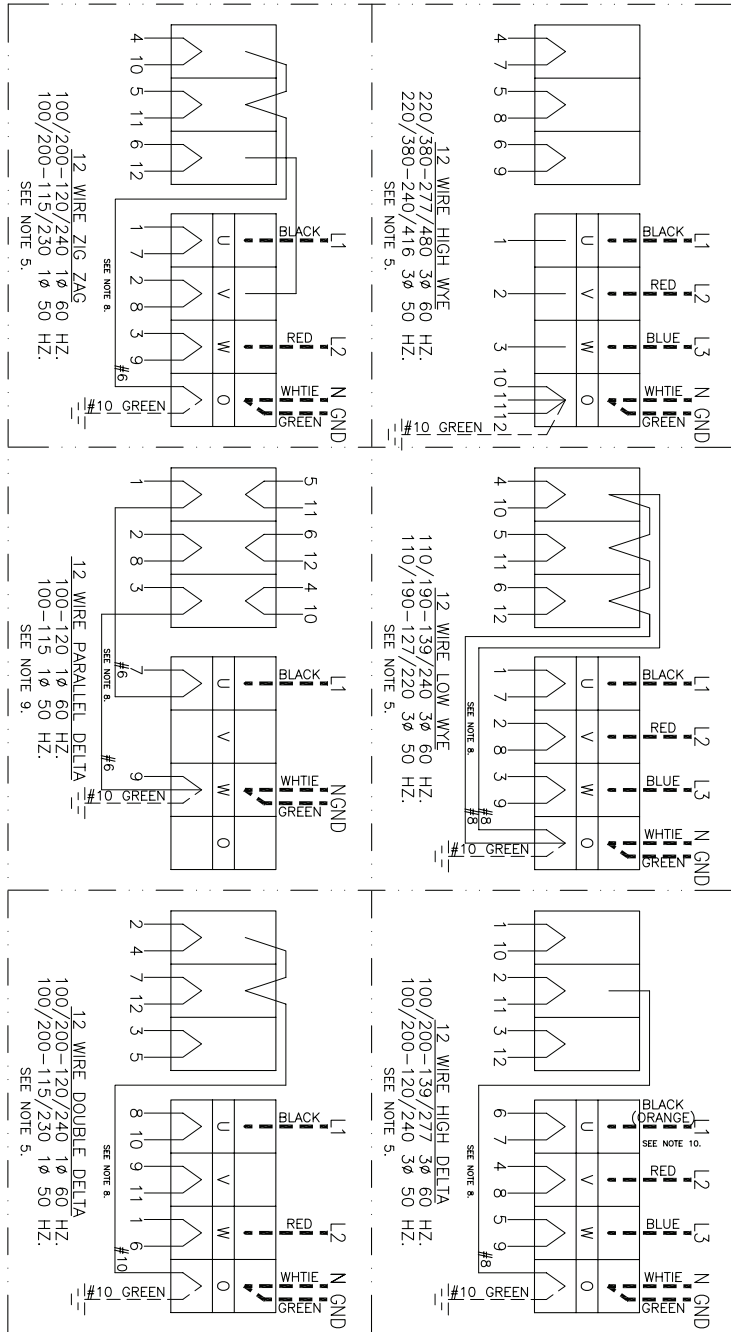

AC Wiring Diagram
12 & 4 Lead Generators, DST-100-2FAK AVR
B-9723A

Wiring Diagram

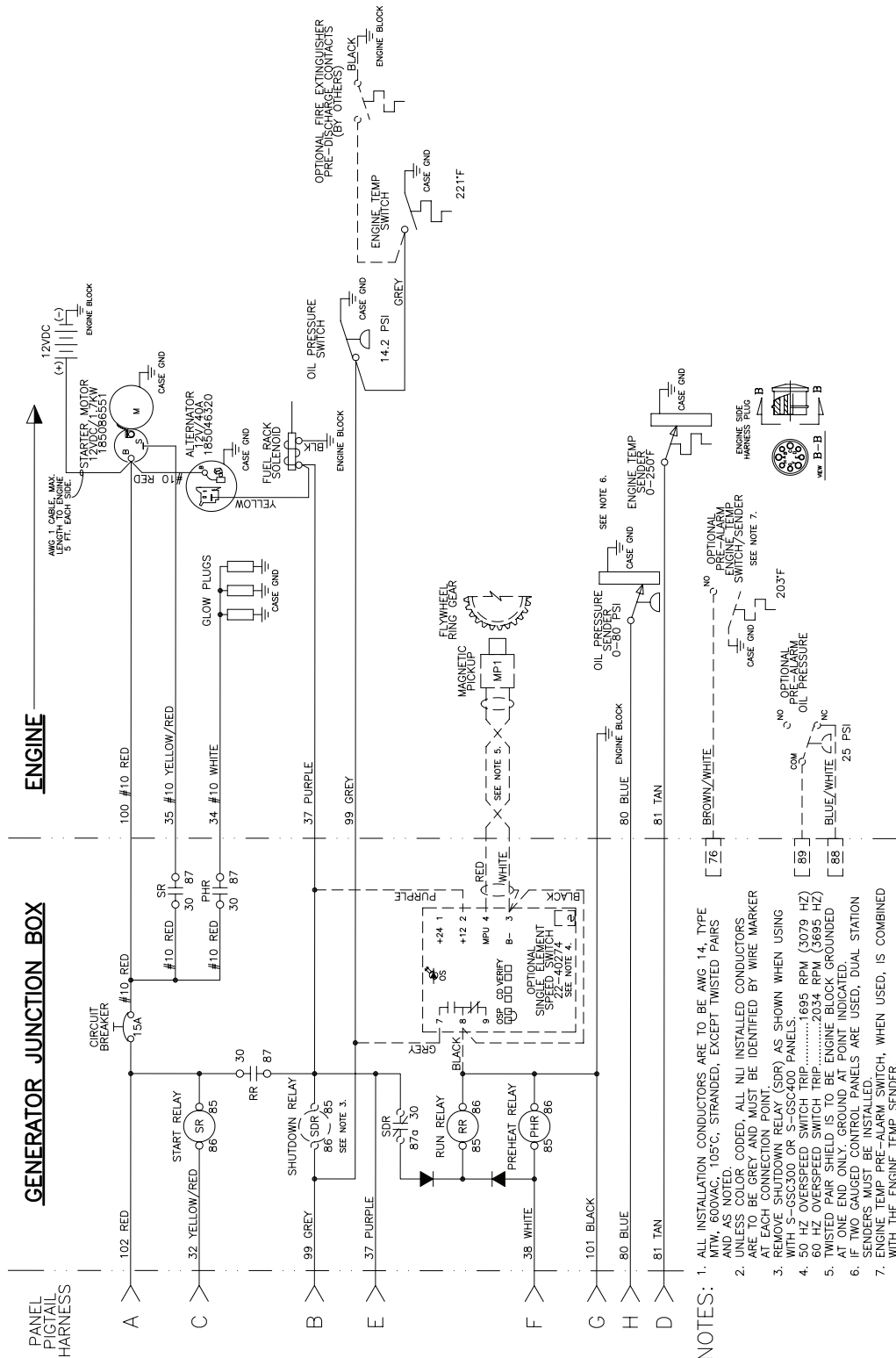

- NOTES:**
1. ALL INSTALLATION CONDUCTORS ARE TO BE AWG 14, TYPE MTW, 600VAC, 105°C, STRANDED, EXCEPT TWISTED PAIRS (UNLESS NOTED). ALL UNINSTALLED CONDUCTORS ARE TO BE GREY AND MUST BE IDENTIFIED BY WIRE MARKER AT EACH CONNECTION POINT.
 2. REMOVE SHUTDOWN RELAY (SDR) AS SHOWN WHEN USING WITH S-GSC300 OR S-GSC400 PANELS.
 3. 50 HZ OVERSPEED SWITCH TRIP.....1695 RPM (3079 HZ)
 4. 60 HZ OVERSPEED SWITCH TRIP.....2034 RPM (3695 HZ)
 5. TWISTED PAIR SHIELD IS TO BE ENGINE BLOCK GROUNDED AT ONE END ONLY. GROUND AT POINT INDICATED.
 6. IF TWO GAUGED CONTROL PANELS ARE USED, DUAL STATION SENSORS MUST BE INSTALLED.
 7. SENSORS MUST BE INSTALLED WITH PREHEAT SWITCH, WHEN USED, IS COMBINED WITH THE ENGINE TEMP SENDER.

DC Wiring Diagram
12 V DC Standard Ground
B-10021

Wiring Diagram

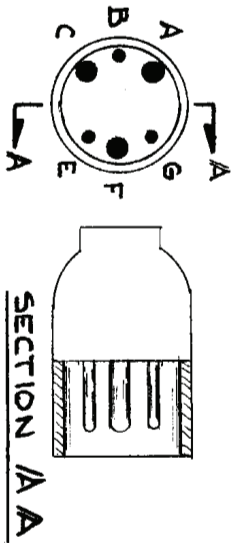
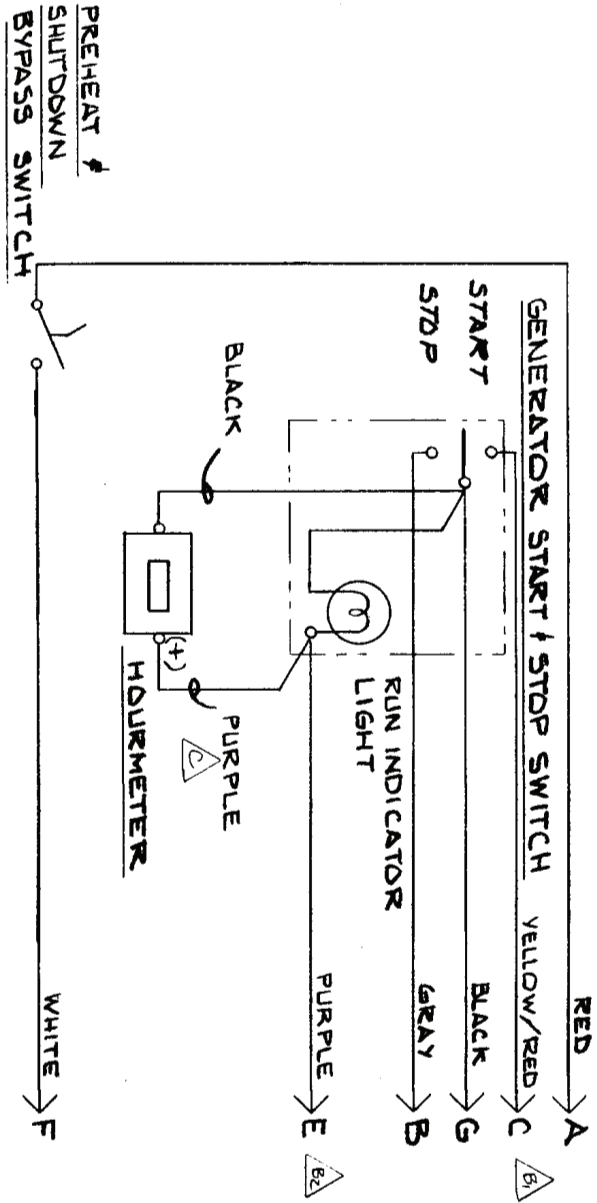

MOLEX 6 PIN PLUG (BLACK)

DC Wiring Diagram
 12 V DC Standard Ground w/ S-1B
 A-3170

Wiring Diagram

CONTROL PANEL

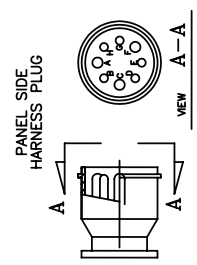
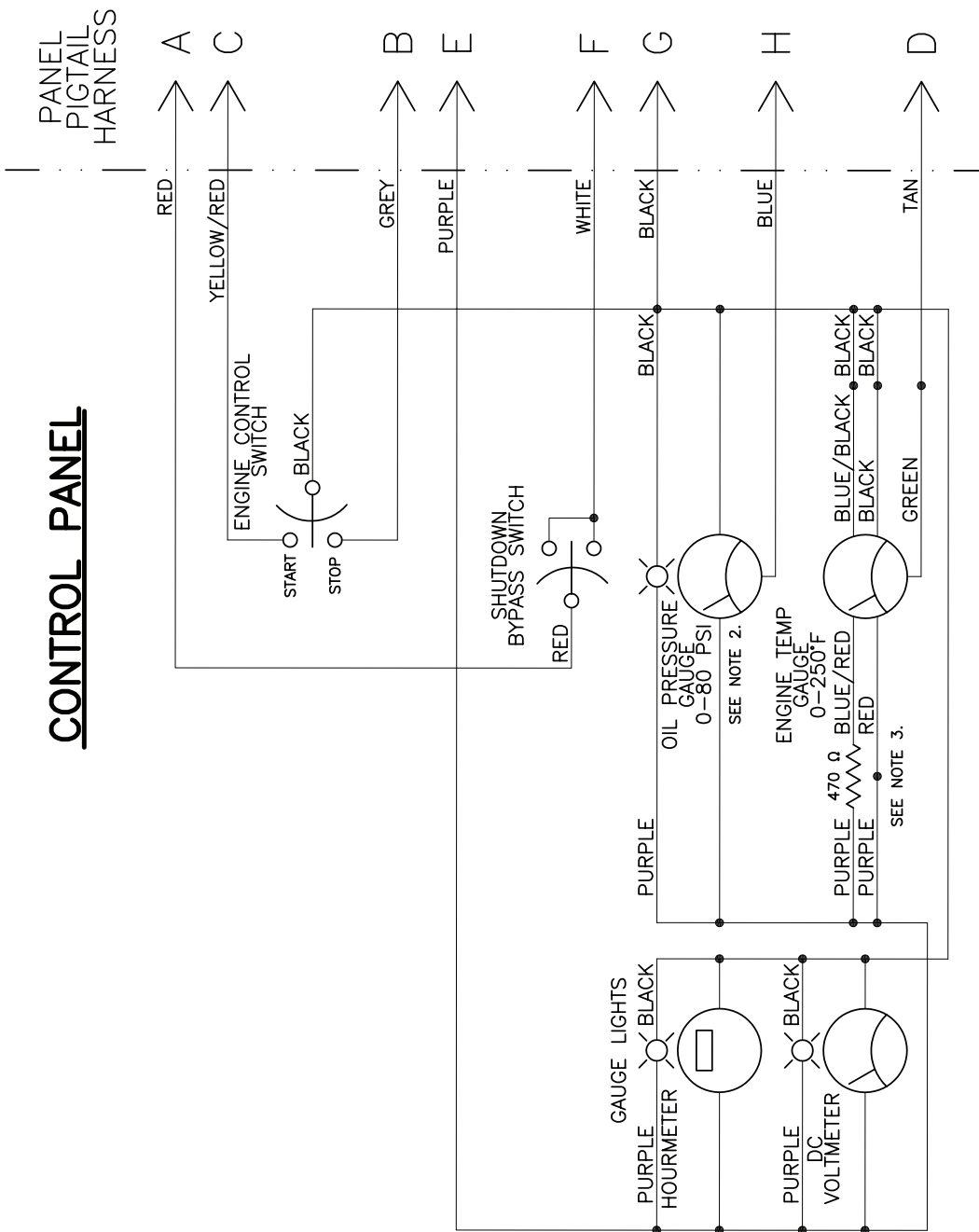

NOTES:

DC Wiring Diagram
12 V DC Standard Ground w/ S-3C
A-12572B



4420 14th Ave. NW., Seattle WA 98107

Tel: (206) 789-3880 • 1-800-762-0165 • www.northern-lights.com

Northern Lights and Lugger are registered trademarks of Northern Lights, Inc.

© 2013 All rights reserved. Litho USA.