

OM864W

For Models: M864W and M864W3

OPERATOR'S MANUAL

Marine Generators | Marine Diesel Engines | Land-Based Generators



LUGGER





— CALIFORNIA —
Proposition 65 Warning:

Diesel engine exhaust and some of its constituents are known to the State of California to cause cancer, birth defects, and other reproductive harm.

Northern Lights
4420 14th Avenue N.W.
Seattle, WA 98107
Tel: (206) 789-3880
Fax: (206) 782-5455

Copyright ©2007 Northern Lights, Inc.
All rights reserved. Northern Lights™, and
the Northern Lights logo are trademarks of
Northern Lights, Inc.

Printed in U.S.A.
PART NO.: OM864W 09/07



OPERATOR'S MANUAL

for Northern Lights® M864W & M864W3 Diesel Generator Sets

**Read this operator's manual thoroughly before starting to operate your equipment.
This manual contains information you will need to run and service your new unit.**

Table of Contents

INTRODUCTION

Models Included	4
Model Numbers	4
Serial Numbers.....	4

WARRANTY	5
-----------------------	---

SAFETY RULES	5
---------------------------	---

COMPONENT LOCATIONS

M864K Generator Set	6 - 7
---------------------------	-------

CONTROL PANELS

Northern Lights Generator Sets	8
--------------------------------------	---

OPERATING PROCEDURES

Break-in Period	9
Before Starting.....	9
Starting.....	10
Operating	10
Stopping	10
Shutdowns and Alarms	11
Spare Parts	11

SERVICING SCHEDULE CHART 12 - 13

SERVICING

Lubrication - General.....	14
Checking Oil.....	14
Oil Changes	14
Changing Oil Filter.....	15
Air Filter	15

SERVICING (Continued)

V-Belts	15
Valve Clearances.....	16
Fuels - General.....	17
Fuel Filters	17
Bleeding the Fuel System	18
Injector Service.....	19
Injection Pump.....	20 - 21
Cooling System	22
Heat Exchanger.....	23
Raw Water Pump	23
Zinc Electrodes	23
Electrical System - General	24
Booster Batteries.....	24
Battery Care	25
Winterizing / Out-of-Service	25

TROUBLESHOOTING

Electrical	26
Engine	27 - 29

DATA SHEET

Specifications and Dimensions	30
-------------------------------------	----

WIRING DIAGRAMS

DC Electrical	31 - 34
AC Electrical	35

Proprietary Information

This publication is the property of Northern Lights, Inc.

It may not be reproduced in whole or in part without the written permission of Northern Lights, Inc.

© Northern Lights, Inc. All rights reserved. Litho U.S.A. Publication number OM864W 09/07

Introduction

The servicing of marine engines and generator sets presents unique problems. In many cases, boats cannot be moved to a repair facility. Marine engines cannot be compared to the servicing of automobiles, trucks, or even farm equipment. Failures often occur in remote areas far from competent assistance. Marine engines are taxed far more severely than auto or truck engines; therefore, maintenance schedules must

be adhered to more strictly. Failures begin with minor problems that are overlooked and become amplified when not corrected during routine maintenance.

As operator, it is your obligation to learn about your equipment and its proper maintenance. This is not a comprehensive technical service manual. Nor will it make the reader into an expert mechanic. Its aim is to aid you in maintaining your unit properly.

Unit Identification

MODELS INCLUDED

This manual covers the operating instructions for:

M864W AND M864W3 marine generator sets, which use the 864 engine block.

Model Numbers

Model numbers give the unit's application, block model, aspiration, and RPM:

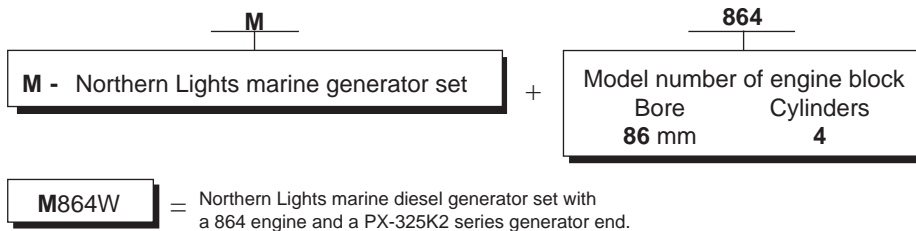

Serial Numbers

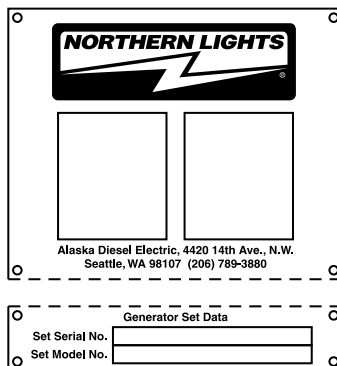

Your set has three serial numbers: ① an engine number stamped on a plate attached to the valve cover, ② a generator end serial number, and ③ a generator set serial number.

NOTE: Always use the generator set serial number when ordering parts or in correspondence. The generator set serial number plate is found on the service side of the generator and resembles the drawing in Figure 1.

Figure 1: Generator set serial number plate.

Warranty

A warranty registration certificate is supplied with your set. It entitles the original purchaser of our equipment to a warranty covering material or assembly faults. The extent of coverage is described in the Limited Warranty Statement. We recommend that you study the statement carefully.

NOTE: If the warranty is to apply, the servicing instructions outlined in this manual must be followed.

If further information is needed, please contact an authorized dealer or the factory.

Safety Rules



CAUTION: *Accident reports show that careless use of engines causes a high percentage of accidents. You can avoid accidents by observing these safety rules. Study these rules carefully and enforce them on the job.*

- Never leave engine without proper security.
- Turn the coolant tank cap slowly to relieve pressure before removing. Add coolant only when the engine is stopped and cool.
- Mount a fire extinguisher near engine.
- Always disconnect the battery ground strap before making adjustments.
- Operate engines in properly ventilated areas.
- Keep trash and other objects away from engine.
- Escaping fluids under pressure can penetrate your skin. Use a piece of cardboard or wood, not your hands, to search for leaks.
- Avoid wearing loose clothing without a belt when working around engines.
- Do not oil or grease engine while it is running.
- Use caution in handling fuel. Never refuel a hot or running engine. Do not smoke while filling fuel tank or servicing fuel system.
- Keep your hands, feet, hair and clothing away from power-driven parts.
- Check for any loose electrical connections or faulty wiring.
- Engines should be operated only by knowledgeable, qualified personnel.
- Look completely around engine to make sure that everything is clear before starting.
- Do not operate an engine that isn't in proper working order. If an unsafe operating condition is noted, tag the set and control panel so others will also know about the problem.
- Provide first aid kits.



CAUTION: *This symbol is used throughout this book to alert you to possible danger areas. Please take special notice of these sections.*

M864W Generator Component Locations

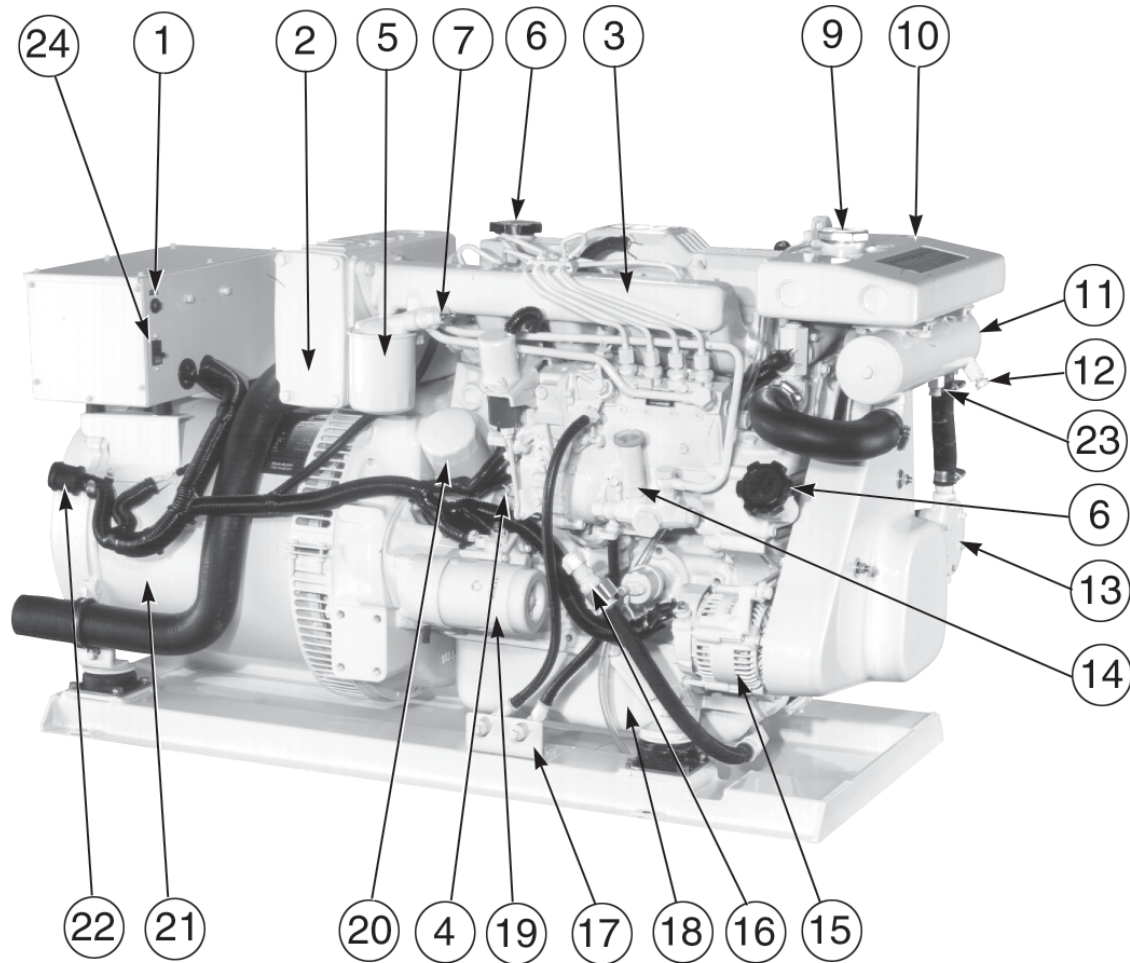

Figure 2: M864W Service Side

- | | | | |
|----------------------------|---------------------------------------------|--------------------|--------------------------------------|
| 1. DC Circuit Breaker | 9. Coolant Fill | 15. DC Alternator | 22. DC Panel Plug-In |
| 2. Air Filter | 10. Expansion Tank | 16. Lube Oil Drain | 23. Heat Exchanger Fresh Water Drain |
| 3. Intake Manifold | 11. Heat Exchanger | 17. Fuel Manifold | |
| 4. Lube Oil Dipstick | 12. Heat Exchanger Raw Water Drain and Zinc | 18. Oil Pan | |
| 5. Secondary Fuel Filter | 13. Raw Water Pump | 19. Starter | |
| 6. Lube Oil Fill | 14. Fuel Primer Pump | 20. Oil Filter | |
| 7. Fuel System Bleed Point | | 21. AC Generator | |

M864W Generator Component Locations

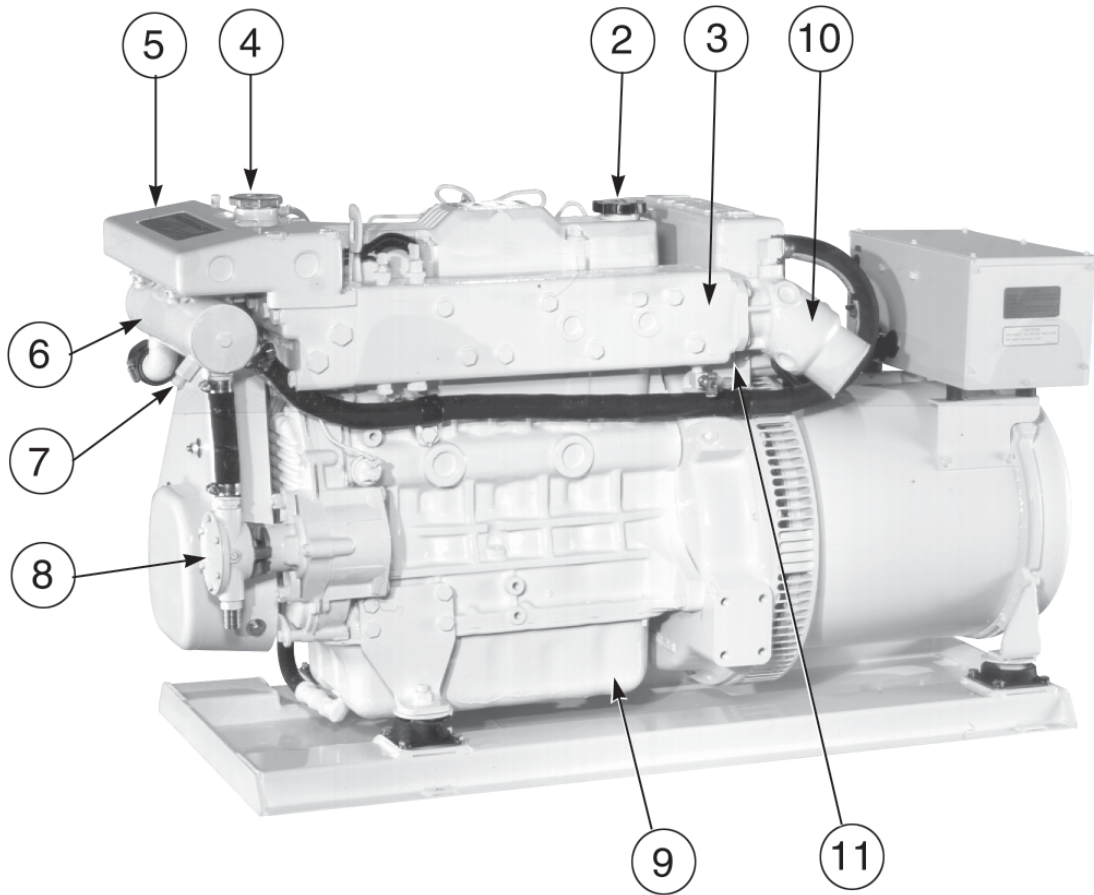

Figure 3: M864W Non-Service Side

- | | |
|---------------------|-----------------------------------------------|
| 2. Lube Oil Fill | 7. Heat Exchanger Raw
Water Drain and Zinc |
| 3. Exhaust Manifold | 8. Raw Water Pump |
| 4. Coolant Fill | 9. Oil Pan |
| 5. Expansion Tank | 10. Wet Exhaust Elbow |
| 6. Heat Exchanger | 11. Manifold Drain |

Control Panels

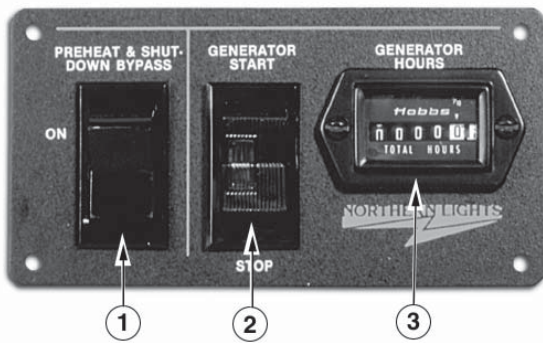

Figure 4-A: Series 1-B Generator Control Panel



Figure 4-B: Series 3 Generator Control Panel



Figure 4-C: Series 4 Generator Control Panel

1. PREHEAT/ SHUTDOWN BYPASS

This switch serves two functions:

- Preheats engine before beginning the starting process. Press switch for 10-20 seconds before attempting startup.
- Bypasses the safety shutdown feature during the starting process. Keep switch engaged while starting engine, and for 2 to 3 seconds afterwards, allowing oil pressure to build beyond shutdown setpoint.

2. ENGINE CONTROL SWITCH

To start the engine, hold this switch in the START position until the engine is running. After the engine starts, release the switch and it will return to RUN position. To stop the engine, hold the switch in the STOP position.

NOTE: The rocker switch is used on Series 1 panels only, and has a light that glows when the set is running.

3. HOUR METER

Keeps track of engine running time.

4. OIL PRESSURE GAUGE

Shows the oil pressure in the engine lubricating system.

5. WATER TEMPERATURE GAUGE

Registers the temperature of the cooling water.

6. D.C. VOLTMETER

When the engine is stopped, the voltmeter indicates the condition of the battery. When the engine is running, the voltmeter indicates the voltage output of the alternator.

For Series 4 Control Panels only:

7. A.C. VOLTMETER

Shows the generator output voltage.

8. FREQUENCY METER (Hertz)

The frequency meter indicates alternating current frequency: 60 Hz (1800 RPM) or 50 Hz (1500 RPM).

9. AMMETER/VOLTMETER SELECTOR

Used to check the voltage and current of each phase. Return to "Amps Off" position when not monitoring.

10. A.C. AMMETER

Shows the generator load on each phase. The phase is selected with the Ammeter Selector switch (#9).

Operating Procedures

BREAK-IN PERIOD

1. The first 100 hours on a new or reconditioned engine are critical to its life and performance.
2. Constantly check the engine temperature and oil pressure gauges.
3. Oil consumption is greater during break-in as piston rings take time to seat.
4. Break-In Oil Changes: Change engine oil and filter at 50 hours. Change oil and filter again at 100 hours (consult Lubricants section for oil recommendation).

Operating Instructions:

Maintain at least a 75% load on your generator set for the first 100 hours. If this is not possible, maintain no less than a 50% load to ensure proper seating of the piston rings. Vary the load to help seat the rings.

BEFORE STARTING

1. Check the water level by removing the pressure cap from the expansion tank. In order to give the cooling water an opportunity to expand, the level should be about 1 in. (2.5 cm) below the filler cap sealing surface when the engine is cold.



CAUTION: *Use protective clothing and open the filler cap carefully when the engine is warm to prevent burns.*

2. Check the oil level in the crankcase with the dipstick. The oil level must be between high and low marks on the stick. Never allow the level to go below this area. Always add the same viscosity of oil as is already in the crankcase.
3. Check the fuel tank level and open any fuel valves on the tank and at the secondary fuel filter.
4. Close the sea-cock, check and clean the sea strainer, and re-open the sea-cock.
5. Place the battery switch in the ON position.

NOTE: The battery switch must always be kept ON while the engine is running. If the switch is turned OFF while the engine is running, the battery charging alternator could be damaged.

Operating Procedures

STARTING

1. Hold the Shutdown Bypass switch in the ON position for 10-20 seconds before starting.
NOTE: Holding the switch too long can burn out the glow plugs.
2. While holding the Shutdown Bypass switch in the ON position, push the Engine Control switch to the START position.
3. As soon as the engine starts, release both switches. Do not crank the starter for more than 20 seconds consecutively. If the engine fails to start with the first attempt, be sure that it has stopped completely before re-engaging the starter.

NOTE: Excessive cranking of the starter on marine sets equipped with a water lift muffler can cause engine damage. If the engine does not start after 3 consecutive 20-second cranks, remove the impeller from the seawater pump. This will prevent the muffler from filling with water and backfilling the exhaust line and engine. Once the engine starts, shut it off immediately and reinstall the impeller.

Restart and check the exhaust overboard outlet for gushes of water.

OPERATING

1. Units with Series 3 and Series 4 Control Panels:
Check gauges often. Oil pressure must be above 15 PSI. The D.C. voltmeter should read between 11 and 15 volts at 80° F (25° C) ambient temperature. The water temperature gauge must be below 200° F (94° C). Check the A.C. voltage and frequency meters (Series 4 panel). If the gauges deviate from normal levels, shut down the generator set and investigate.
2. Let the unit run unloaded for a three to five minute warm-up period.
3. Add electrical load.

STOPPING

1. Remove electrical load from the generator set.
2. Run the engine for a three to five minute cool-down period.
3. Move the Engine Control switch to the STOP position until the engine stops completely.
4. Shut off seacock, fuel valve, and battery switch.

SHUTDOWNS AND ALARMS

1. Your unit is fitted with a system to protect it from high water temperature or low oil pressure.
 - a. Generator sets have shutdown systems to stop the engine. They have no warning horns.
 - b. Other alarms and shutdowns are available as optional equipment.

NOTE: If your unit is equipped with optional shutdowns and alarms, do not rely on the warning or shutdown system to the exclusion of careful gauge monitoring. Watching your gauges can prevent damage to the unit and dangerous power losses.

2. Do the following when your warning or shutdown system is activated:
 - a. Check the temperature gauge. If above 205° F (96° C), shut off the engine immediately.
 - b. Use the Trouble Shooting Guide on page 26 to isolate the cause of the overheat.



CAUTION: Do not remove the water fill cap of an overheated engine. Escaping high temperature steam can cause severe burns. Allow the engine to cool and then remove the cap slowly using protective clothing.

- c. Make repairs and restart after the temperature gauge registers below 200° F (94° C).
 - d. Watch the temperature gauge regularly and turn off the unit if the temperature rises above 205° F (96° C). Repeat troubleshooting.
3. If shutdown is activated and the temperature gauge shows temperature within normal temperature range:
 - a. Check the engine crankcase oil level.
 - b. If the oil level is low, fill with recommended lubricating oil and restart. Watch the oil pressure gauge carefully and shut off the engine if it does not show a normal reading (20-60 PSI) after a few seconds of operation.
 - c. If the oil level is normal, DO NOT restart the engine. Call your dealer for assistance.

SPARE PARTS

1. ADE recommends that you keep the following spare parts on hand for field service. The parts are available from your local Northern Lights dealer. Some marine models may already have "On-Board Kits," a handy box that contains the most common parts you will need.
 - a. Primary and secondary fuel filter elements
 - b. Oil filters
 - c. Air filter elements
 - d. Alternator belt
 - e. Thermostat and gaskets
 - f. Seawater pump impeller and gaskets
 - g. Glow plugs
 - h. Injector and washer
2. If your set is operating a long distance from a servicing dealer, add the following:
 - a. Complete set of injectors
 - b. Copper washers for injector change
 - c. Complete set of glow plugs
 - d. Fuel lift pump

Servicing Schedule Chart

The Servicing Schedule Chart below shows the service schedule required for proper maintenance of your generator set. More detailed coverage of each Service Point (SP) is listed on the page noted in the 'page' column.

DAILY:

SP1 Check oil level in engine
 SP8 Check primary fuel filter
 SP14 Check cooling water level
 Check sea strainer

SP4 Check air cleaner
 SP9 Change primary fuel filter element
 SP10 Change secondary fuel filter
 SP18 Check zinc electrodes

AFTER FIRST 50 HOURS:

SP2/3 Change engine oil and filter
 SP5 Check V-belt tension
 SP7 Adjust valves
 SP19 Check electrolyte level in batteries

EVERY 750 HOURS:

SP7 Check valve clearances
 SP12 Check injectors
 SP15 Check and flush cooling system
 SP17 Change impeller
 SP20 Check state of charge of batteries

EVERY 50 HOURS:

SP5 Check V-belt tension
 SP19 Check electrolyte level in batteries

EVERY 1500 HOURS:

SP12 Check injectors, clean tips

AFTER FIRST 100 HOURS:

SP2/3 Change engine oil and filter

EVERY 2400 HOURS:

SP13 Check fuel injection pump
 SP16 Check and clean heat exchanger

EVERY 200 HOURS:

SP2/3 Change engine oil and filter

EVERY 3000 HOURS:

SP12 Remove injectors for adjustment, clean & repair

SERVICE POINT	PAGE	OPERATION	DAILY	50 Hours	100 Hours	200 Hours	750 Hours	1500 Hours	2400 Hours	3000 Hours
ENGINE:										
SP1	12	Check oil level	•							
SP2	12	Change engine oil ^{1, 5}			•	•				
SP3	13	Change lube oil filters ^{1, 5}			•	•				
SP4	13	Check air cleaner ^{1, 4}				•				
SP5	13	Check V-belt tension ¹		•						
SP7	14	Check valve clearances ⁵					•			
FUEL SYSTEM:										
SP8	15	Check primary filter ²	•							
SP9	15	Change primary filter element ^{2, 3}				•				
SP10	15	Change secondary fuel filter ^{1, 3}				•				
SP11	16	Bleed the fuel system ³								
SP12	17	Check injectors ^{1, 6}					•	•		•
SP13	18	Check fuel injection pump							•	
COOLING SYSTEM:										
SP14	20	Check cooling water level	•							
SP15	20	Check and flush cooling system					•			
SP16	21	Check and clean heat exchanger							•	
SP17	21	Change impeller in raw water pump ^{1, 3}					•			
SP18	21	Check zinc electrodes ⁴				•				
ELECTRICAL SYSTEM:										
SP19	23	Check electrolyte level in batteries ^{1, 4}		•						
SP20	23	Check condition of batteries with hydrometer ¹					•			
OUT OF SERVICE:										
SP23	23	Winterizing or out-of-service ³								

1) Perform all maintenance once a year even if hour level has not been reached.
 2) Consult manufacturer's maintenance schedule, note on chart.
 3) Whenever necessary.
 4) More often if necessary.
 5) After first 50 hours.

6) To insure that your engine stays in compliance with applicable EPA & CARB emission standards, the following additional maintenance procedures & intervals must be maintained.
 1500 Hours: Fuel injectors are to be removed & injector tips cleaned.
 3000 Hours: Fuel injectors removed for adjustment, cleaning, & repair.

Service Record

Service Point	OPERATION	HOURS/ DATE									
50 HOURS											
SP5	Check V-belt tension										
SP19	Check electrolyte in batteries										
200 HOURS											
SP2	Change engine oil										
SP3	Change lubricating oil filters										
SP4	Check air cleaner										
SP8	Change primary filter element (Racor)										
SP10	Change secondary fuel filter										
SP18	Check zinc electrodes										
EVERY 750 HOURS											
SP7	Check valve clearances										
SP12	Check injectors										
SP15	Check and flush cooling system										
SP17	Change impeller in seawater pump										
SP20	Check condition of batteries with hydrometer										
1500 HOURS											
SP12	Check injectors, clean tips										
2400 HOURS											
SP13	Check fuel injection pump										
SP16	Check and clean heat exchanger										
SP22	Check and clean oil cooler on reverse gear										
3000 HOURS											
SP12	Clean and repair injectors										

Servicing

LUBRICATION - GENERAL

1. Use only clean, high quality lubricants stored in clean containers in a protected area.
2. These lubricants are acceptable:
 - a. API Service CC/CD/CE single viscosity oils.
 - b. API Service CC/CD/SF multi-viscosity oils.
3. Use the proper weight oil for your average operation temperature.

Air Temperature	Single Viscosity	Multi-Viscosity
Above 32° F (0° C)	SAE 30W	SAE 15-40W
-10° to 32° F (-23° to 0° C)	SAE 10W	SAE 10-30W

Figure 5: Lube Oils

4. Never put additives or flushing oil in crankcase.

SP1. CHECKING OIL LEVEL

1. While the engine is stopped, check the oil level in the crankcase with the dipstick daily. The oil level must be between the high and low marks on the stick. Fill with the recommended oil, and fill only to the high mark on the dipstick. Follow the lubrication recommendations in Figure 5.

SP2. OIL CHANGES

1. The set is delivered with special break-in oil. Change the engine oil and oil filter after 50 hours of operation. Use Service CC 30 weight oil during the first 100 hours.
2. Change the oil and filter again at 100 hours using the oil recommended in the above diagram. After this, change oil and filter every 200 hours.
3. During intermittent cold weather operation, change oil every 100 hours or six weeks, whichever comes first.
4. Change oil at any seasonal change in temperature when a new viscosity of oil is required.
5. Change oil when engine is warm but not hot.
6. Dispose of waste oil in an approved manner.
7. Never use a flushing oil.
8. Remove cap. Drain oil. Replace cap and tube.
9. Refill engine with recommended oil.
10. Engine capacity with new oil filter is:
Model 864W7.8 qts. (7.4 liters)

SP3. CHANGING LUBE OIL FILTER

1. Change the lube oil filter every 200 hours.
2. Use a filter wrench to remove old filter. Dispose of filter in approved manner.
3. Make sure the gasket from the old filter is removed and discarded. Clean mount face.
4. Spread a thin film of engine oil on the rubber gasket on the new filter and screw it on nipple until gasket meets the sealing surface.
5. Using hands only – no wrench – tighten filter one-half turn farther. Overtightening can do damage to filter housing.
6. Fill engine with recommended oil. Start engine and check for leakage. Stop engine, wait 3 minutes, and check oil level. Add additional oil if necessary.
7. Oil filter part number is:
Model 864W #24-08701.

SP4. AIR CLEANER

1. Visually inspect air cleaner every 200 hours. In dusty conditions, check more often.
2. Remove the plate on the side of the air intake manifold. Remove and inspect the foam element. If dirty, wash element in soapy water. Rinse and dry thoroughly before reinstalling.

NOTE: Make absolutely sure no impurities enter the engine while changing the element, and do not run the engine with the air cleaner removed.

Do not clean the filter with diesel fuel, solvent, or gasoline. Serious engine damage can result.

SP5. V-BELTS

1. Check the tension and wear on the V-belt after every 50 hours.
2. Use your thumb to press on the belt at the midpoint between the crankshaft and alternator pulleys. The tension is correct if the belt can be depressed about 3/8 in. (10 - 15 mm) with 22 lbs. (10 kg) force.

Servicing

SP7. VALVE CLEARANCES

1. Readjust valve clearance after first 50 hours of operation. Adjust valves every 750 hours thereafter.
2. Warm up the engine to 167° F - 185° F (75° C - 85° C). Shut off fuel and battery.
3. Rotate the crankshaft in a clockwise direction to set cylinder No. 1 to the top dead center. Top dead center (TDC) is when notch "TDC" on the pulley aligns with the pointer and the two valves on cylinder No. 4 "rock". Rocking is when the rocker arms (for the two valves on a given cylinder) are moving in opposite directions, one up closing the valve and one down opening the other valve. The moment when the two rocker arms are exactly aligned with each other is when they "rock".

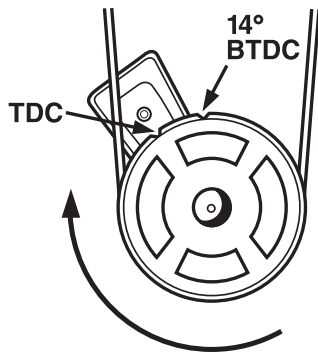

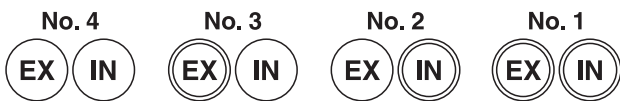

Figure 6: Timing Marks

4. Measure the valve clearance for each of the valves (shown as  in Figure 7). Standard valve clearances for a hot engine are:
 Intake (IN).....0.007 - 0.009 in. (0.18 - 0.22 mm)
 Exhaust (EX).....0.013 - 0.015 in. (0.33 - 0.37 mm)





-  Adjustable when cylinder No. 1 is at Top Dead Center (TDC)
-  Adjustable when cylinder No. 4 is at Top Dead Center (TDC)

Figure 7: Valve Sequence

5. To adjust valve clearance, loosen the lock nut on the adjustment screw. Insert a feeler gauge between the rocker arm and the valve stem cap. Adjust until the feeler gauge slides with a slight drag. Tighten the lock nut and recheck the clearance (Figure 8).

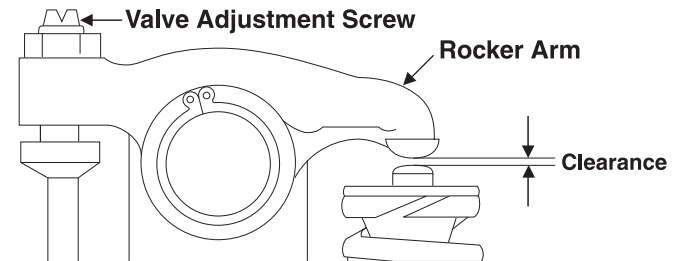



Figure 8: Valve Adjustment

6. Rotate the crankshaft in clockwise direction one full turn to set cylinder No. 4 to top dead center (TDC). Adjust the remaining valves (shown as  in Figure 7).
7. Replace the rocker arm cover.

FUELS - GENERAL

1. Use only clean, high quality fuels of the following specifications, as defined by ASTM designation D975 for diesel fuels:
 - a. Use grade No. 2 diesel at ambient temperatures above freezing 32° F (0° C).
 - b. International fuel specifications:
 - ISO-8217-DMA
 - BS 2869 Part 1 Class A1
 - BS 2869 Part 2 Class A2
2. Use fuel having less than 1% sulphur (preferably less than 0.5%).
3. The cetane number should be a minimum of 45.
4. DO NOT use these unsuitable grades of fuel:
 - a. Domestic heating oils, all types.
 - b. Class B engine.
 - c. Class D domestic fuels.
 - d. Class E, F, G or H industrial or marine fuels.
 - e. ASTM-D975-60T No. 4-D and higher number fuels.
5. Storing fuel:
 - a. Keep dirt, scale, water, and other foreign matter out of fuel.
 - b. Avoid storing fuel for long periods of time.
 - c. Fill the fuel tank at the end of each day's operation. This will reduce condensation.

SP8-10. FUEL FILTERS

1. Your generator set should have a primary fuel filter installed. We recommend the Northern Lights brand of fuel filter-water separators.
 - a. Check the primary fuel filter daily as recommended by the filter manufacturer. Empty the collection bowl as necessary.
 - b. Change the element as often as necessary or every 200 hours.
 - c. If the bowl fills with water, change the primary and secondary element immediately.

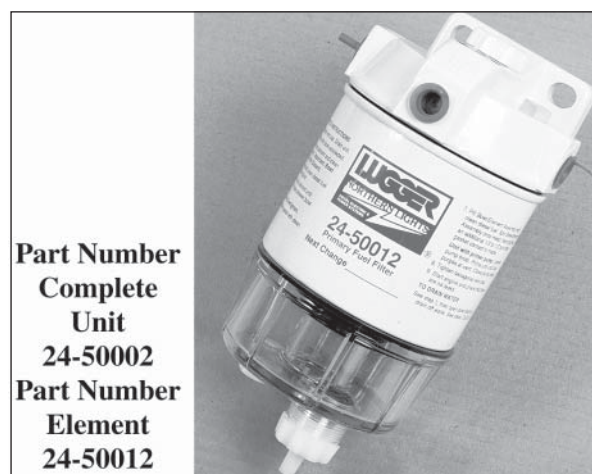

Figure 9: Primary Fuel Filter

2. Change secondary fuel filter every 200 hours.

NOTE: The fuel filter on the engine is considered the “secondary fuel filter”.

- a. Remove the spin-on filter by turning it counter-clockwise with a filter wrench. Fill the new cartridge with fuel and install it after applying engine oil to the gasket surface. Screw on the filter until the gasket surface comes into contact with the sealing surface of the filter base. Then, tighten it two-thirds of a turn by hand. Do not overtighten.
- b. Fuel filter part number is:
 - Model 864W#24-52020

Servicing

SP11. BLEEDING THE FUEL SYSTEM



CAUTION: Escaping diesel fuel under pressure can penetrate skin causing serious personal injury. Before disconnecting lines be sure to relieve all pressure. Before applying pressure, be sure all connections are tight and lines, pipes and hoses aren't damaged. Fuel escaping from a very small hole can be almost invisible. Use a piece of cardboard or wood, rather than hands, to search for suspected leaks. If injured by escaping fuel, see a doctor at once. Serious infection or reaction can develop if proper medical treatment isn't administered immediately.

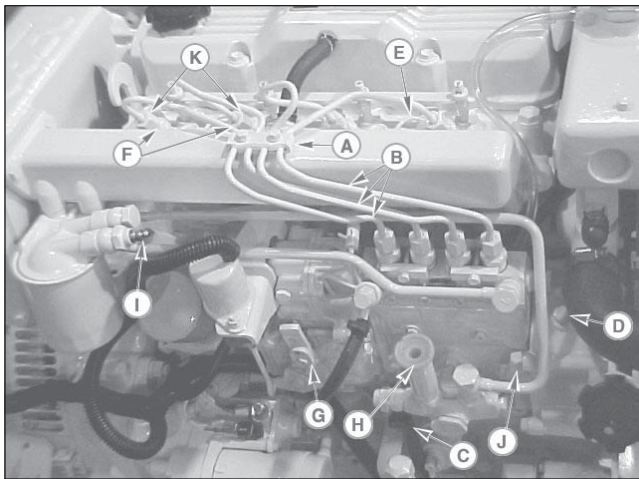

Figure 10: Fuel System

1. The fuel system is self-bleeding. However, any system may need manual bleeding when:
 - a. A new fuel filter is installed;
 - b. The engine has run out of fuel;
 - c. The fuel lines, injection pump or any other fuel system component has been removed and installed.
2. Loosen bleed nipple (Figure 10-I) on top of the fuel filter. Pump hand primer (Figure 10-H) on fuel lift pump until pure fuel (no bubbles) escapes from the bleed nipple (Figure 10-I). Tighten bleed nipple.
3. If the engine does not start after this bleeding process, loosen a fuel line at the injector (Figure 10-F) while cranking the engine with the starter motor until pure fuel escapes. Then tighten the connection. Do each line **one-at-a-time**.
4. After the engine has started, use a piece of cardboard to look for fuel leaks.

SP12. INJECTOR SERVICE

1. Injectors should be checked every 750 hours. This check should be made by a Northern Lights dealer or local injection repair station.

To insure that your engine stays in compliance with applicable EPA and CARB emission standards, the following maintenance procedures and intervals must be maintained.

1500 Hours: Fuel injectors are to be removed and injector tips cleaned.

3000 Hours: Fuel injectors removed for adjustment, cleaning, and repaired.



CAUTION: Escaping diesel fuel under pressure can have sufficient force to penetrate the skin causing serious personal injury. If injured by escaping fuel, see a doctor at once.

2. Injector Removal:

- a. Clean loose dirt from around the injectors and the fuel lines.
- b. Relieve high pressure in the fuel lines by loosening the delivery line flare nuts at each injector.

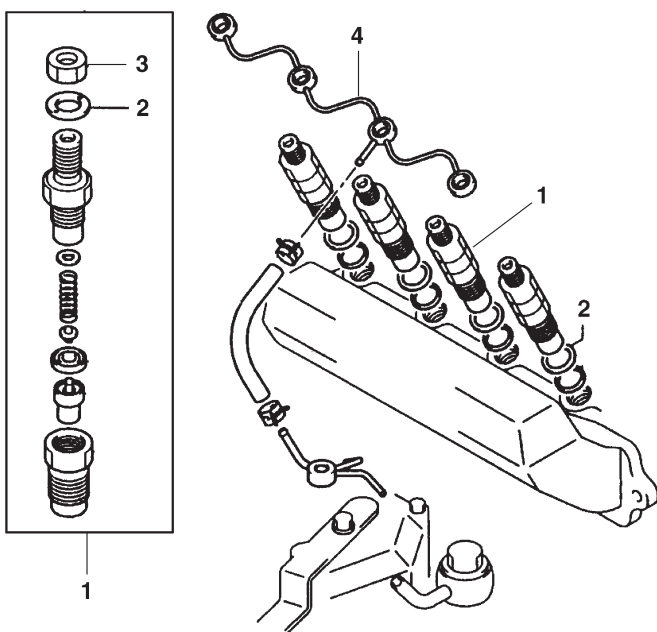

Figure 11: Injectors

- c. Remove delivery lines (Figure 12-B) by disconnecting from injectors and injection pump. Remove all lines as an assembly; do not remove the spacers. Cover the ends of the lines, the injector inlets and injection pump outlets to keep dirt out.
- d. Remove the return line retaining nuts, washers, and return line.
- e. Loosen the injector (Figure 12-I). Remove the injector.
- f. Remove the injector seat. Cover the holes to prevent debris from entering the cylinders.

NOTE: Do not use pry bars to remove injectors from the cylinder head.

3. Injector Repair and Cleaning

- a. Take injectors to your Northern Lights dealer or local injection repair station for testing and service.

4. Injector Installation:

- a. Install new injector seal washer seat and injector. Tighten the injector (Figure 11-1) to 42 - 50 ft/lbs. (5.8 - 6.9 k/gm). Do not overtighten.
- b. Reinstall the return line (Figure 11-4) using new sealing washers (Figure 11-2). Tighten bolts (Figure 11-3) to 18 - 25 ft/lbs (2.5 - 3.5 k/gm).

NOTE: Overtightening can damage injectors.

- c. Reinstall injection lines (Figure 12-B). Tighten flare nuts (Figure 12-K) at injection pump to 18.2 - 25.3 ft/lbs (2.5 - 3.5 k/gm). Leave the lines loose at injectors for bleeding.
- d. Bleed the injection lines (Figure 12-B). Crank the engine to fill the lines. Tighten flare nuts at injectors to 18.2 - 25.3 ft/lbs (2.5 - 3.5 k/gm).
- e. Start the engine and check for leaks using a piece of paper or cardboard. Do not use your hand to check for leaks.

Servicing

SP13. INJECTION PUMP

1. Since operating conditions may vary considerably, it is difficult to give a definite interval for checking the injection pump. But as a rule, pump settings, maximum speed, idle speed and exhaust smoke should be checked after every 2400 hours of operation. Service of the fuel injection pump should only be done if checks indicate pump malfunction.
2. Black smoke can be an indication of pump malfunction. Before servicing the pump, check other possible causes:
 - a. Check cleanliness of the air filter.
 - b. Check valve clearances.
 - c. Clean and check injectors.
3. Any repair which involves disassembly of the injection pump must be carried out by specially trained mechanics with the proper tools and test equipment.

NOTE: All warranties on the engine become null and void if the injection pump seals are broken by unauthorized persons.

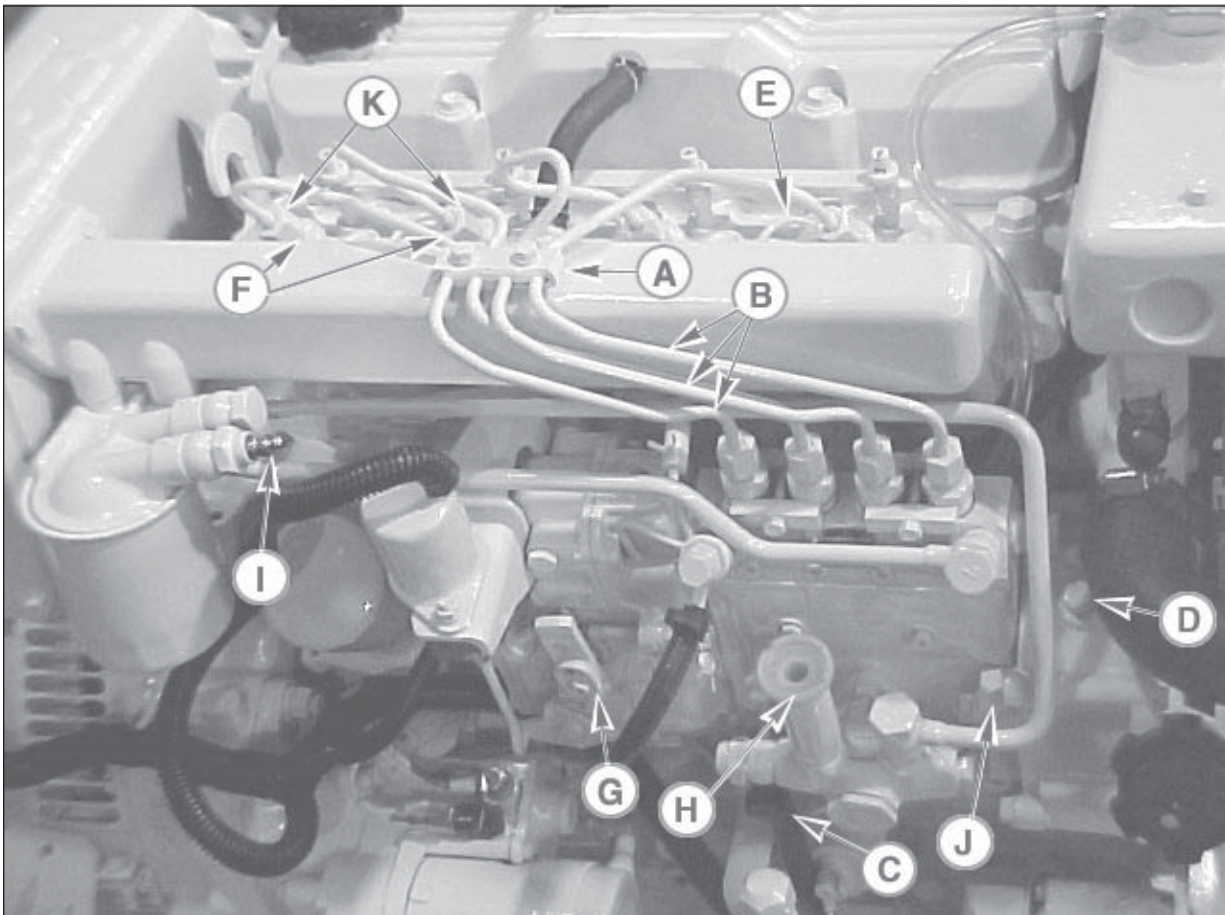

Figure 12: Fuel System

- | | | | |
|---------------------------------|----------------------------|-----------------------------|------------------------------|
| A. Injection Line Clamps | D. Timing Mark Plug | G. Throttle Lever | J. (4) Mounting Bolts |
| B. Fuel Injection Lines | E. Fuel Return Line | H. Hand Priming Pump | K. Flare Nuts |
| C. Fuel Feed Line | F. Injector (4) | I. Air Vent Point | |

4. Injection Pump Removal:



CAUTION: Escaping diesel fuel under pressure can have sufficient force to penetrate the skin, causing serious personal injury. If injured by escaping diesel fuel, see a doctor at once.

- a. Clean the injection pump, hoses, and area around the pump with a cleaning solvent or steam cleaner.

NOTE: Never steam clean or pour cold water on an injection pump while the engine is running or the pump is warm.

- b. Remove the injection lines (Figure 12-B) from the pump and injectors. Remove all lines as an assembly. Do not remove the spacers. Cover the ends of the lines, the injector inlets, and the injection pump outlets to keep dirt out of the injectors, lines, and pump.
- c. Remove the plug (Figure 12-D) from the timing case cover. Use an indelible marker to put a mark on the injection pump gear through the plug hole. You will use this mark to align the pump during reassembly. Do not rotate the crankshaft after marking.
- d. Remove the 4 mounting nuts (Figure 12-J). One (1) is found on the back side of the injection pump, and three (3) are found on the front side.
- e. Take the pump to your Northern Lights dealer or an injection repair station for testing and service.

5. Injection Pump Installation:

- a. Reverse the removal process.
- b. Make sure the mark on the gear shows through the plug hole.
- c. Torque mounting bolts to 12 - 18 ft/lbs (1.7 - 2.5 k/gm).

INJECTION PUMP TIMING

1. The injection pump is timed at the factory and the pump body and mounting flange are marked. If pump timing is questionable, follow the procedure below.
2. Check Injection Pump Timing:
 - a. Bleed air from the fuel system (see page 16).
 - b. Remove the fuel injection line from the No. 1 fuel delivery valve on the injection pump (Figure 13).

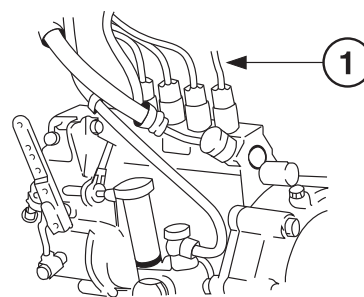

Figure 13: Fuel Injection Lines

- c. Pressurize the system with the hand primer pump (Figure 12-H).
- d. Slowly rotate the crankshaft by hand in clockwise direction until fuel just begins to rise in the No. 1 delivery valve.
- e. The crankshaft pulley notch mark for 13° Before Top Dead Center (BTDC) should now align with the timing pointer (Figure 14). If it does not, the injection pump needs to be timed.

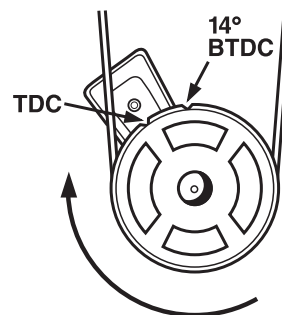

Figure 14: Timing Marks

Servicing

COOLING SYSTEM - GENERAL

NOTE: Be sure to close the sea-cock before working on the engine cooling system.



CAUTION: *The cooling water in the engine reaches extremely high temperatures. You must use extreme caution when working on hot engines to avoid burns. Allow the engine to cool before working on the cooling system. Open the filler cap carefully, using protective clothing when the engine is warm.*

SP14. CHECK THE COOLANT LEVEL

1. Check the coolant level each day before starting the engine.
 - a. Check the water level by removing the pressure cap from the radiator. In order to give the cooling water an opportunity to expand, the level should be about 1 in. (2.5 cm) below the filler cap sealing surface when the engine is cold.
 - b. The pressure valve in the filler cap releases when the pressure is approximately 7 PSI (0.5 kg/cm²). Use a cap pressure tester to check cap if you suspect it is faulty.

SP15. COOLING SYSTEM FLUSHING

1. Flush the cooling system every 750 hours or every 12 months, whichever comes first.
2. Remove fill cap and open drains on engine block. The hex-headed engine block drain is on the service side of the engine below the intake manifold, next to the flywheel housing.
3. Pour clean water into the engine until water coming from engine is clear of discoloration. Close drains and refill the engine with recommended coolant mixture.
4. Use 50% water / 50% ethylene glycol antifreeze mix. Antifreeze mixture is recommended as a good year-round coolant.
5. Check hoses and connections and repair any leakage.
6. Start the engine and check for leaks. Run the engine for five minutes, then shut it down. Let engine cool, and then check the coolant level in the engine. Add coolant as needed.

NOTE: Be sure to open the sea-cock after working on the engine cooling system and starting the engine.

SP16. HEAT EXCHANGER

1. Clean the heat exchanger core once a year or after 2400 hours of operation.
2. Drain the expansion tank and heat exchanger.
3. Remove the heat exchanger end covers.
4. Clean the inside of the exchanger core tubes using a metal rod. Flush, inspect, and clean again if necessary.
5. Reassemble the heat exchanger. Fill the cooling system. Start the engine and check for leaks.

SP17. RAW WATER PUMP

1. Change the raw water pump impeller every 750 hours, or as needed.
2. Remove the pump cover. Pry out the impeller using needle-nose pliers or two screwdrivers. Be sure to remove all pieces of the failed impeller.

NOTE: Place some kind of protection under the screwdrivers in order to not damage the pump housing.

3. Clean the inside of the housing.
4. Press in the new impeller and place the sealing plug in the outer end of the impeller center if this has not already been done.

NOTE: Make sure that there is always an extra impeller and cover gasket in reserve on board.

SP18. ZINC ELECTRODES

1. A zinc electrode is installed in the heat exchanger cooling system to protect the engine from electrolysis. Check it faithfully every 200 hours. If you are in warm saltwater, or where electrolysis is a known problem, check it more often.
2. Remove the zinc holder from the bottom of the exchanger (Figure 2-12). This will drain raw water from the exchanger.
3. Scrape or steel brush the zinc electrode clean. If more than 50% of the electrode is corroded away, replace it with a new zinc. The electrode screws out of the holder.
4. Reinstall the zinc holders. Be sure the threads are clean for good metal-to-metal contact. Do not use thread sealant.
5. Refill the cooling system. Start the engine and check for leaks.

PTO

Check the manufacturer's manual for servicing requirements for the Optional PTO with electric clutch.



Figure 15: Optional PTO with electric clutch

Servicing

GENERATOR END

The maintenance and operation recommendations for the generator end are in a separate Owner's Manual. If you do not have one of these manuals, contact your local dealer.

ELECTRICAL SYSTEM - GENERAL

1. Never switch the battery switch off or break the circuit between the alternator and the batteries while the engine is running. Alternator damage can result.
2. Do not reverse the polarity of the battery cables when installing the battery.

BOOSTER BATTERIES



CAUTION: Battery gas can explode. Keep all flames and sparks away from batteries.

1. Before changing or using booster batteries, check the battery electrolyte level. Add distilled water if necessary.
2. Booster and main batteries must have the same voltage rating.
3. First, connect the positive (+) terminal of the booster battery to the positive (+) terminal of the main battery. Then, connect the negative (-) terminal of the booster battery to ground on the engine block (Figure 16).
4. Remove the booster battery after starting the engine.
5. Sealed Batteries:
See the manufacturer's charging and booster instructions.

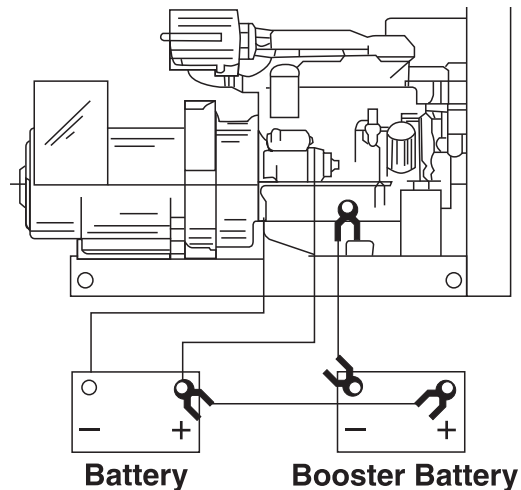

Figure 16: Booster Battery Connections

SP19-20. BATTERY CARE

1. Check the electrolyte level every 50 hours, or once a month. Add distilled water to the manufacturer's recommended level.
2. Batteries, cables, and cable terminals should be checked and cleaned every 100 hours. Clean corrosion with a water and baking soda solution. Flush with clean water. Tighten terminals and grease them to inhibit future corrosion.
3. Check the battery condition with a hydrometer every 750 hours.

SP23. WINTERIZING / OUT-OF-SERVICE

NOTE: Remember to close the sea-cock before opening drain cocks.

1. Change the crankcase oil and filter.
2. Drain fresh water and seawater cooling systems completely. Flush fresh water systems and refill with the proper antifreeze mixture.
3. Drain the water supply lines and wet exhaust line.
4. Loosen the seawater pump cover and drain the pump.
5. Loosen the alternator belt.
6. Disconnect and clean the battery. Remove the battery to a warm storage place if possible.
7. Clean the outside of the unit. Paint any scratched or chipped surfaces. Put corrosion preventative on all exposed metal surfaces.

Troubleshooting

DC ELECTRICAL SYSTEM

PROBLEM	POSSIBLE CAUSE	RECOMMENDATION(S)
Battery Will Not Charge	Loose or corroded connections	• Clean and tighten battery connections.
	Sulfated or worn out batteries	• Check specific gravity of each battery. • Check electrolyte level of each battery.
	Loose or defective alternator belt	• Adjust belt tension. • Replace belt.
Starter Inoperative	Check DC circuit breaker	• If the breaker is tripped, reset it.
	Loose or corroded connections	• Clean and tighten loose battery and harness plug connection.
	Low battery condition	• Check specific gravity of each battery. • Check electrolyte level of each battery.
	Defective electrical system ground wire:	• Repair or replace.
Starter Cranks Slowly	Low battery condition	• Battery is too small. • Battery cables are too small.
	Check specific gravity of each battery	• Replace battery if necessary.
	Check electrolyte level of each battery	• If low, fill cells with distilled water.
	Crankcase oil too heavy	• Fill with oil of appropriate viscosity.
	Loose or corroded connections	• Clean and tighten loose connections.
Entire Electrical System Does Not Function	Check DC circuit breaker	• If breaker is tripped, reset it.
	Faulty connection	• Clean and tighten battery and harness plug connections.
	Sulfated or worn out batteries	• Check specific gravity and electrolyte level of each battery.

If you cannot correct problems with these procedures, see your **Northern Lights** dealer.

ENGINE

PROBLEM	POSSIBLE CAUSE	RECOMMENDATION(S)
Engine Hard to Start or Will Not Start	Improper starting procedure	<ul style="list-style-type: none"> • See starting section of this manual. Take special note of Bypass Switch operation.
	No fuel	<ul style="list-style-type: none"> • Check level of fuel in fuel tank.
	Low battery condition	<ul style="list-style-type: none"> • Check electrolyte level and condition.
	Excessive resistance in starting circuit	<ul style="list-style-type: none"> • Clean and tighten all battery connections.
	Crankcase oil too heavy	<ul style="list-style-type: none"> • Use oil of proper viscosity.
	Improper type of fuel	<ul style="list-style-type: none"> • Consult fuel supplier and use proper type of fuel for operating condition.
	Water, dirt or air in fuel system	<ul style="list-style-type: none"> • Drain, flush, fill and bleed system.
	Clogged primary fuel filter element	<ul style="list-style-type: none"> • Clean or replace filter element.
Engine Runs Irregularly or Stalls Frequently	Clogged secondary fuel filter element	<ul style="list-style-type: none"> • Replace filter element.
	Dirty or faulty injection nozzles	<ul style="list-style-type: none"> • Have your dealer check injection nozzles.
	Below normal engine temperature	<ul style="list-style-type: none"> • Remove and check thermostat.
	Clogged primary fuel filter element	<ul style="list-style-type: none"> • Clean or replace filter element.
	Clogged secondary fuel filter element	<ul style="list-style-type: none"> • Replace secondary filter element.
	Water or dirt in the fuel system	<ul style="list-style-type: none"> • Drain, flush, fill and bleed system.
	Dirty or faulty injection nozzles	<ul style="list-style-type: none"> • Have your dealer check injection nozzles.
	Air in fuel system	<ul style="list-style-type: none"> • Inspect clamps and hoses on suction side of fuel pump for air leak.
Lack of Engine Power	Improper type of fuel	<ul style="list-style-type: none"> • Consult fuel supplier and use proper type of fuel for operating condition.
	Engine overloaded	<ul style="list-style-type: none"> • Reduce the load.
	Intake air restriction	<ul style="list-style-type: none"> • Service air cleaner.
	Clogged primary fuel filter element	<ul style="list-style-type: none"> • Clean or replace filter element.
	Clogged secondary fuel filter element	<ul style="list-style-type: none"> • Replace filter element.
	Overheated engine	<ul style="list-style-type: none"> • See “Engine Overheats” in next category.
	Improper type of fuel	<ul style="list-style-type: none"> • Consult fuel supplier and use proper type of fuel for operating conditions.
	Below normal engine temperature	<ul style="list-style-type: none"> • Remove and check thermostat.
	Improper valve clearance	<ul style="list-style-type: none"> • Reset valves. Best done by dealer.
Dirty or faulty injection nozzles	<ul style="list-style-type: none"> • Replace injectors. Best done by dealer. • See your local dealer. 	

Troubleshooting

ENGINE

PROBLEM	POSSIBLE CAUSE	RECOMMENDATION(S)
Engine Overheats	Engine overloaded	• Reduce the electrical load.
	Low coolant level	• Fill tank or radiator to proper level. • Check hoses for loose connections and leaks.
	Keel cooling tubes (marine sets) have been painted	• Remove paint from tubes.
	Cooling system needs flushing	• Flush cooling system.
	Defective thermostat	• Remove and check thermostat.
	Defective temperature gauge	• Check water temperature with thermometer and replace gauge if necessary.
	Water pump impeller worn or broken	• Check the impeller and replace if necessary.
Engine Knocks	Insufficient oil	• Call your dealer.
	Injection pump out of time	• Call your dealer.
	Below normal engine temperature	• Check your thermostats. • Check water temperature to see if temperature gauge is working properly.
	Faulty fuel injector	• Call your dealer.
	Engine overheating	• See “Engine Overheating” section.
High Fuel Consumption	Improper type of fuel	• Use correct fuel for temperature.
	Clogged or dirty air cleaner	• Service air cleaner.
	Engine overloaded	• Reduce the electrical load.
	Improper valve clearance	• See your dealer.
	Injection nozzles dirty	• See your dealer.
	Injection pump out of time	• See your dealer.
	Engine not at proper temperature	• Check your thermostats. • Check water temperature with thermometer and replace gauge if necessary.
Below Normal Engine Temperature	Thermostats not working properly	• Check thermostats.
	Temperature gauge not working properly	• Check water temperature with thermometer.
Low Oil Pressure	Low oil level	• Fill crankcase to proper level.
	Improper type of oil	• Drain and fill crankcase with correct oil.
	Partially plugged oil filter	• Replace filter.

If you cannot correct problems with these procedures, see your **Northern Lights** dealer.

ENGINE

PROBLEM	POSSIBLE CAUSE	RECOMMENDATION(S)
High Oil Consumption	Break-in period	• Oil consumption decreases after break in.
	Crankcase oil too light	• Use proper viscosity oil.
	Oil leaks	• Check for leaks in lines around gaskets and drain plug.
	Crankcase over full	• Remove excess oil.
Engine Emits Black or Gray Exhaust Smoke	Clogged or dirty air cleaner	• Service air cleaner.
	Defective muffler (back pressure too high)	• Have dealer check back pressure.
	Improper fuel	• Use correct fuel for temperature.
	Engine overloaded	• Reduce the electrical load.
	Injection nozzles dirty	• See your dealer.
	Engine out of time	• See your dealer.
Engine Emits White Smoke	Improper fuel	• Use correct fuel for temperature.
	Cold engine	• Warm up engine to normal operating temperature.
	Defective thermostat	• Remove and check thermostat.
	Engine out of time	• See your dealer.
	Low Compression Pressure	• See your dealer.

If you cannot correct problems with these procedures, see your **Northern Lights** dealer.

Specifications and Dimensions

Rated RPM/Frequency Kilowatt Rating	1800/60 Hz 25 kW	1500/50 Hz 20 kW
General Information		
Cylinders	In-line 4	In-line 4
Displacement	151.7 CID (2.49 l)	151.7 CID (2.49 l)
Cycle	4	4
Bore x Stroke	3.39 in (86 mm) x 4.21 in (107 mm)	3.39 in (98 mm)x 4.21 in (107 mm)
Rotation (Facing Flywheel)	counterclockwise	counterclockwise
Compression Ratio	21.5:1	21.5:1
Crankcase Capacity (Including Oil Filter)	7.8 qts. (7.4 l)	7.8 qts. (7.4 l)
Aspiration	Natural	Natural
Flywheel Housing Size	SAE 4	SAE 4
Flywheel Drive Size	SAE C-110	SAE C-110
Dry Weight Complete Unit with Heat Exchanger Cooling	3 ϕ - 980 lbs., 1 ϕ - 965 lbs.	3 ϕ - 980 lbs., 1 ϕ - 965 lbs.
Height	26.88 in (683 mm)	26.88 in (683 mm)
Width	20.75 in (527 mm)	20.75 in (527 mm)
Length	47.0 in (1194 mm)	47.0 in (1194 mm)
Cooling System		
Approximate Cooling System Capacity with Heat Exchanger	2.2 gal (8.3 ltr)	2.2 gal (8.3 ltr)
Minimum Through-Hull Diameter	.75 in (19 mm)	.75 in (19 mm)
Sea Water Pump Inlet Hose (Inside Diameter)	.75 in (19 mm)	.75 in (19 mm)
Minimum Sea Water Discharge	.75 in (19 mm)	.75 in (19 mm)
Heat Rejection to Jacket Water	1788 BTU/min	1400 BTU/min
Fresh Water Pump Capacity	11.5 gal/min (43.5 l/m)	9.5 gal/min (36 l/m)
Maximum Sea Water Pump Suction Head	39 in (1 m)	39 in (1 m)
Keel Cooler Tube Length (Turbo Tube)	8 ft (2.44 m)	8 ft (2.44 m)
Keel Cooler Head Diameter	1.25 in (32 mm)	1.25 in (32 mm)
Keel Cooler Water Hose ID Discharge and Suction	1.5 in (38 mm)	1.5 in (38 mm)
Electrical		
Minimum Battery Capacity	220 Amp/hour - 640 CCA	220 Amp/hour - 640 CCA
Battery Cable Size	#1/0 up to 10 ft (3 m)	#1/0 up to 10 ft (3 m)
Instrument Harness Length	20 ft (6.1 m)	20 ft (6.1 m)
Starting Voltage, Negative Ground	12 VDC	12 VDC
Air		
Generator Cooling Air Flow, 3 ϕ & 1 ϕ	292 cfm (8.3 m ³ /m)	225 cfm (6.4 m ³ /m)
Air Consumption	67.2 cfm (1.89 m ³ /m)	54 cfm (1.53 m ³ /m)
Maximum Engine Room Vent	39 sq in (193 cm ²)	39 sq in (193 cm ²)
Maximum Exhaust Back Pressure	48 in. H ₂ O (1219 mm H ₂ O)	48 in. H ₂ O (1219 mm H ₂ O)
Wet Exhaust Elbow OD	3 in (75 mm)	3 in (75 mm)
Fuel		
Minimum Suction Line	3/8 in (10 mm)	3/8 in (10 mm)
Minimum Return Line	3/8 in (10 mm)	3/8 in (10 mm)
Maximum Fuel Transfer Pump Suction	39 in (100 mm)	39 in (100 mm)
Specific Fuel Consumption at Maximum Load	0.414 lbs/hp/hr	0.409 lbs/hp/hr
Approximate Fuel Rate at Maximum Load	2.3 gal/h (8.7 l/hr)	1.8 gal/h (6.8 l/hr)

NOTE: Specifications are subject to change without notice.

DC Wiring Diagram

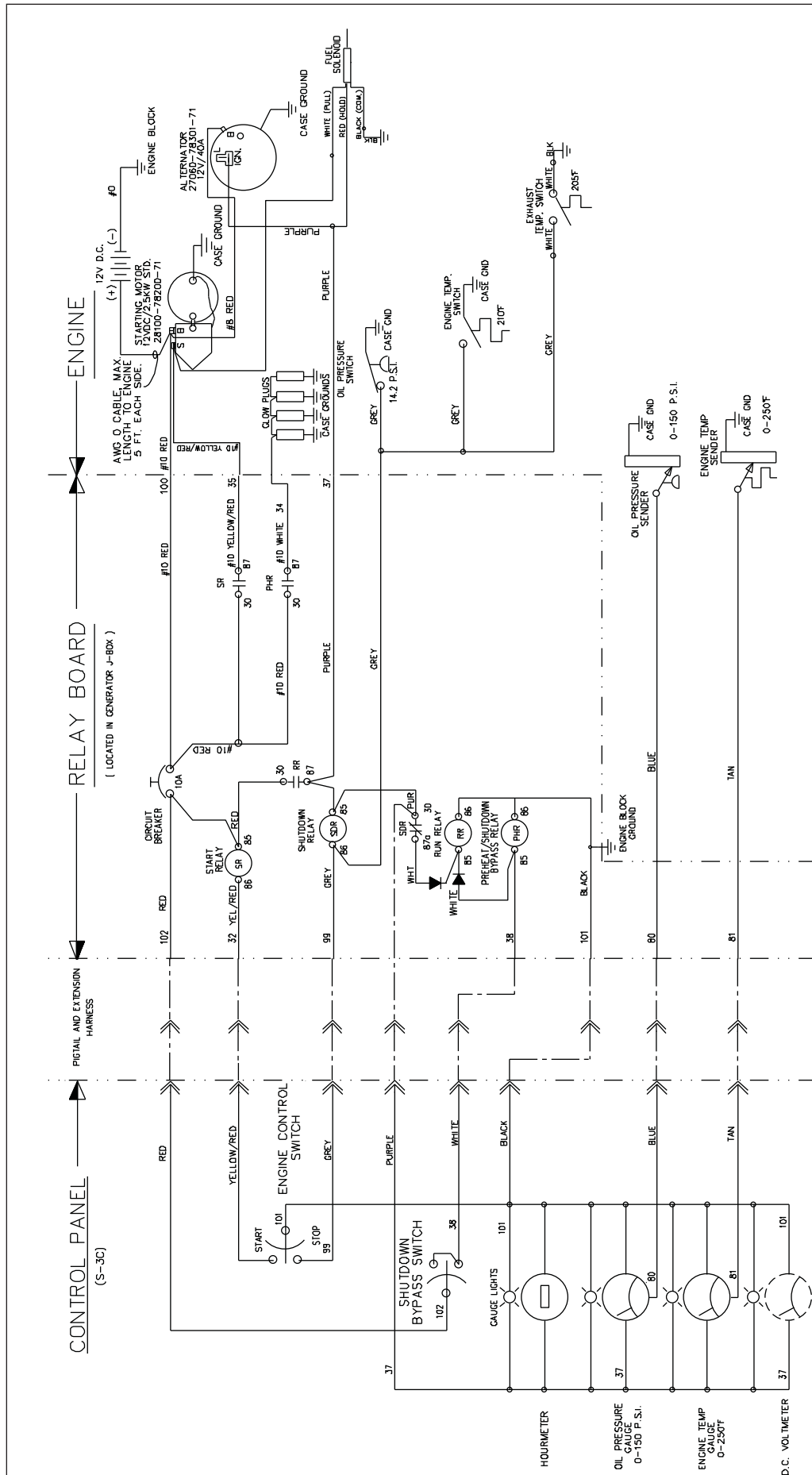

- NOTES:
1. ALL INSTALLATION CONDUCTORS TO BE AWG 14, 105°C, TYPE MTW, MULTISTRAND, 600 VAC, EXCEPT AS INDICATED.
 2. UNLESS COLOR CODED, ALL A.D.E. INSTALLED CONDUCTORS ARE TO BE GREY AND MUST BE IDENTIFIED BY WIRE MARKER AT EACH CONNECTION POINT.

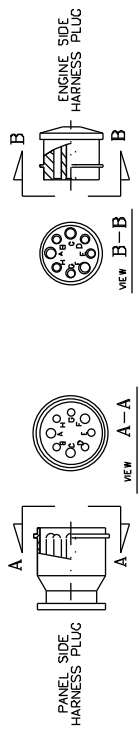

Northern Lights DC Wiring Diagram –
 Model M864W 12V Standard Ground
 Drawing C-5657

DC Wiring Diagram

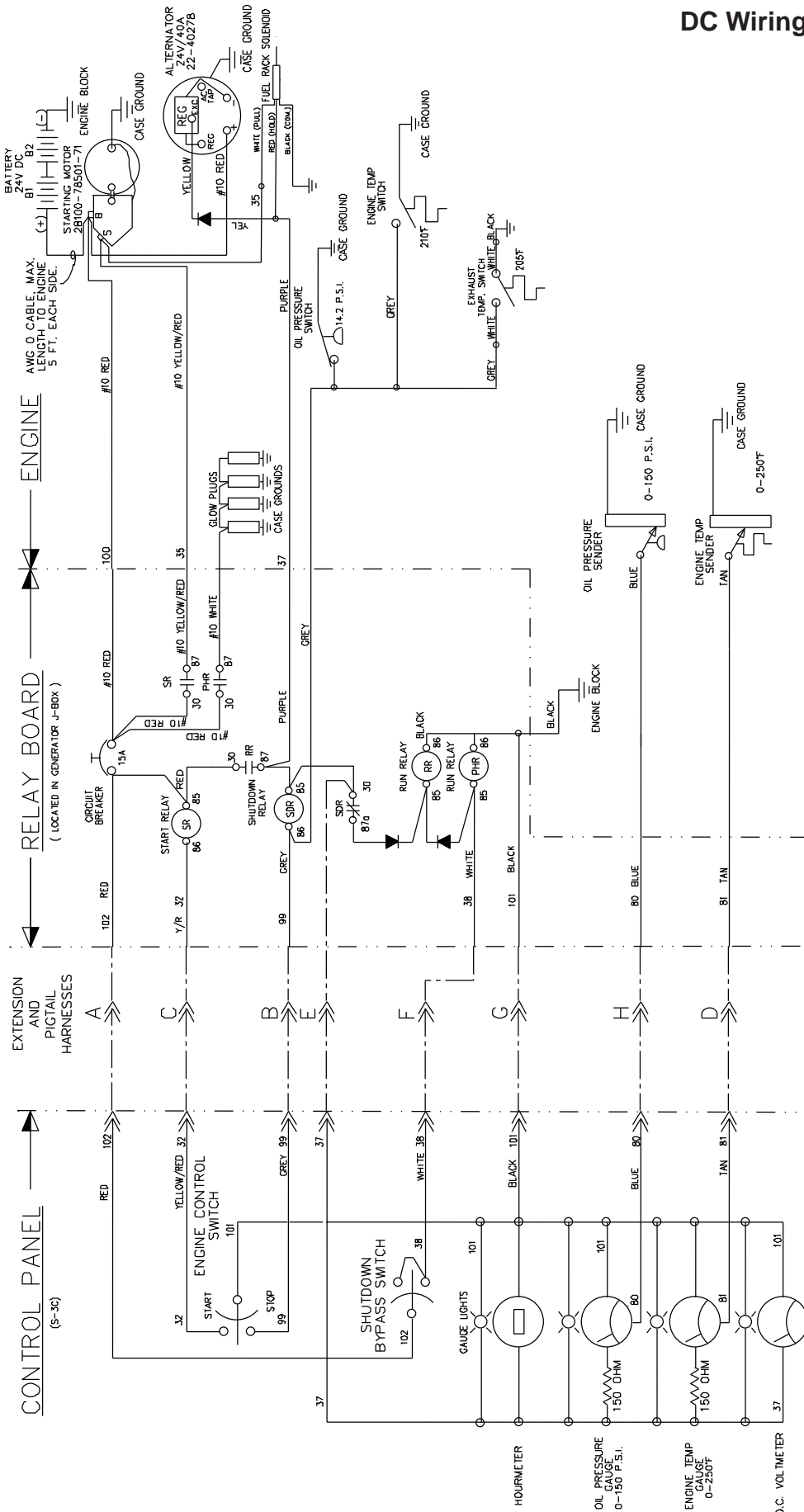

- NOTES:**
1. ALL INSTALLATION CONDUCTORS TO BE AWG 14, 105°C, 600VAC, TYPE MTW, MULTISTRAND, EXCEPT AS NOTED.
 2. UNLESS COLOR CODED, ALL A.D.E. INSTALLED CONDUCTORS ARE TO BE GREY AND MUST BE IDENTIFIED BY WIRE MARKER AT EACH CONNECTION POINT.

Northern Lights DC Wiring Diagram –
M864W 24V Standard Ground
Drawing C-5659

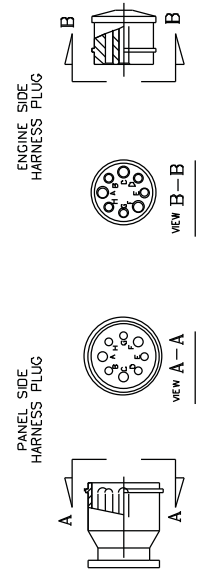

DC Wiring Diagram

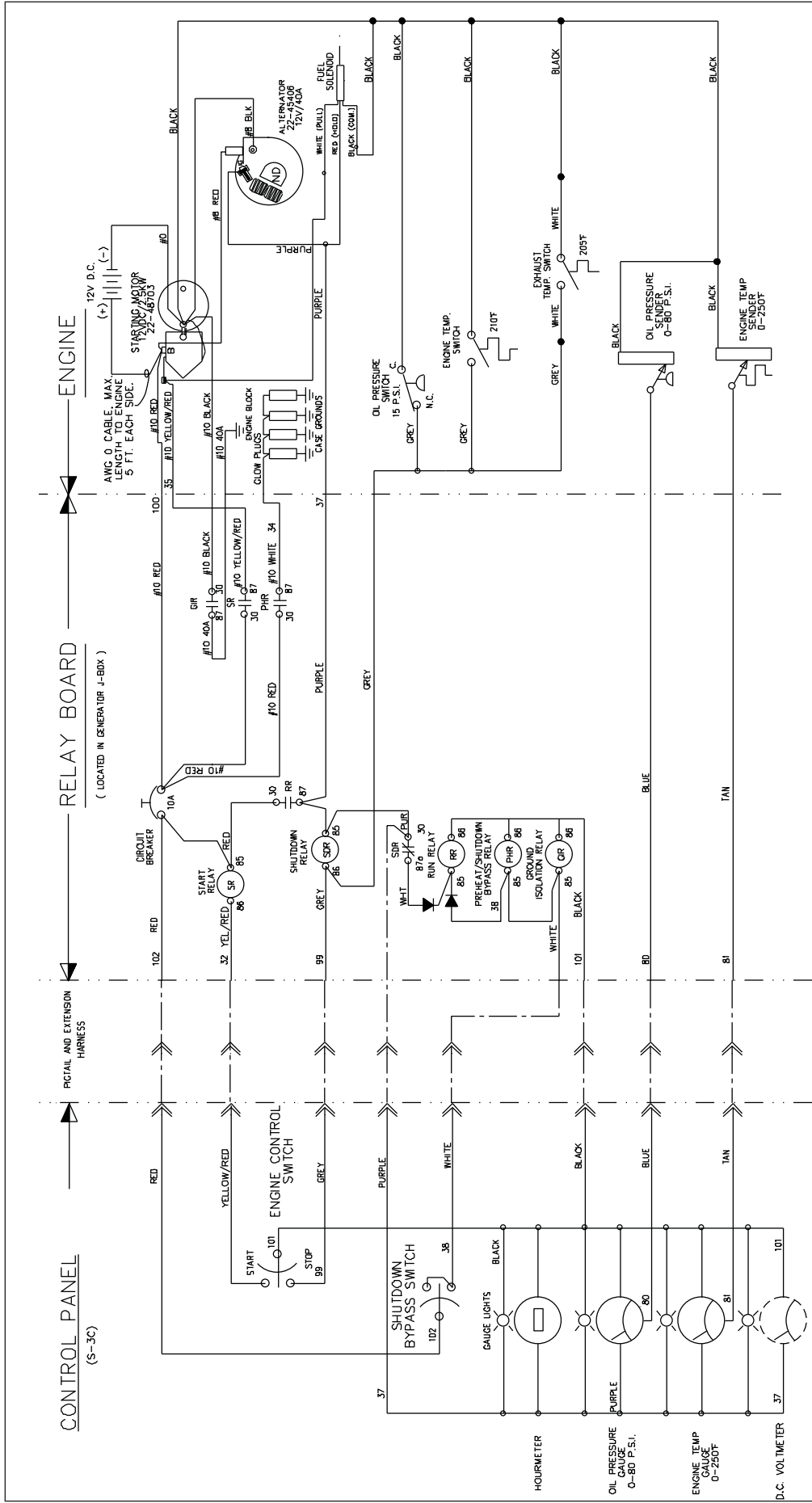

NOTES:

1. ALL INSTALLATION CONDUCTORS TO BE AWG 14, 105°C, TYPE MTW, MULTISTRAND, 600 VAC, EXCEPT AS INDICATED.
2. UNLESS COLOR CODED, ALL A.D.E. INSTALLED CONDUCTORS ARE TO BE GREY AND MUST BE IDENTIFIED BY WIRE MARKER AT EACH CONNECTION POINT.

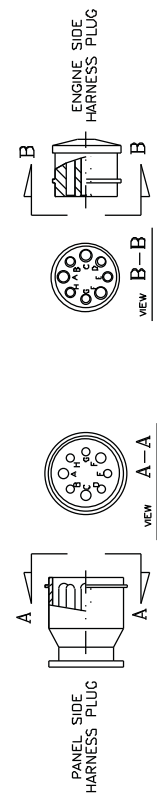

Northern Lights DC Wiring Diagram –
M864W 12V Isolated Ground
Drawing C-5658

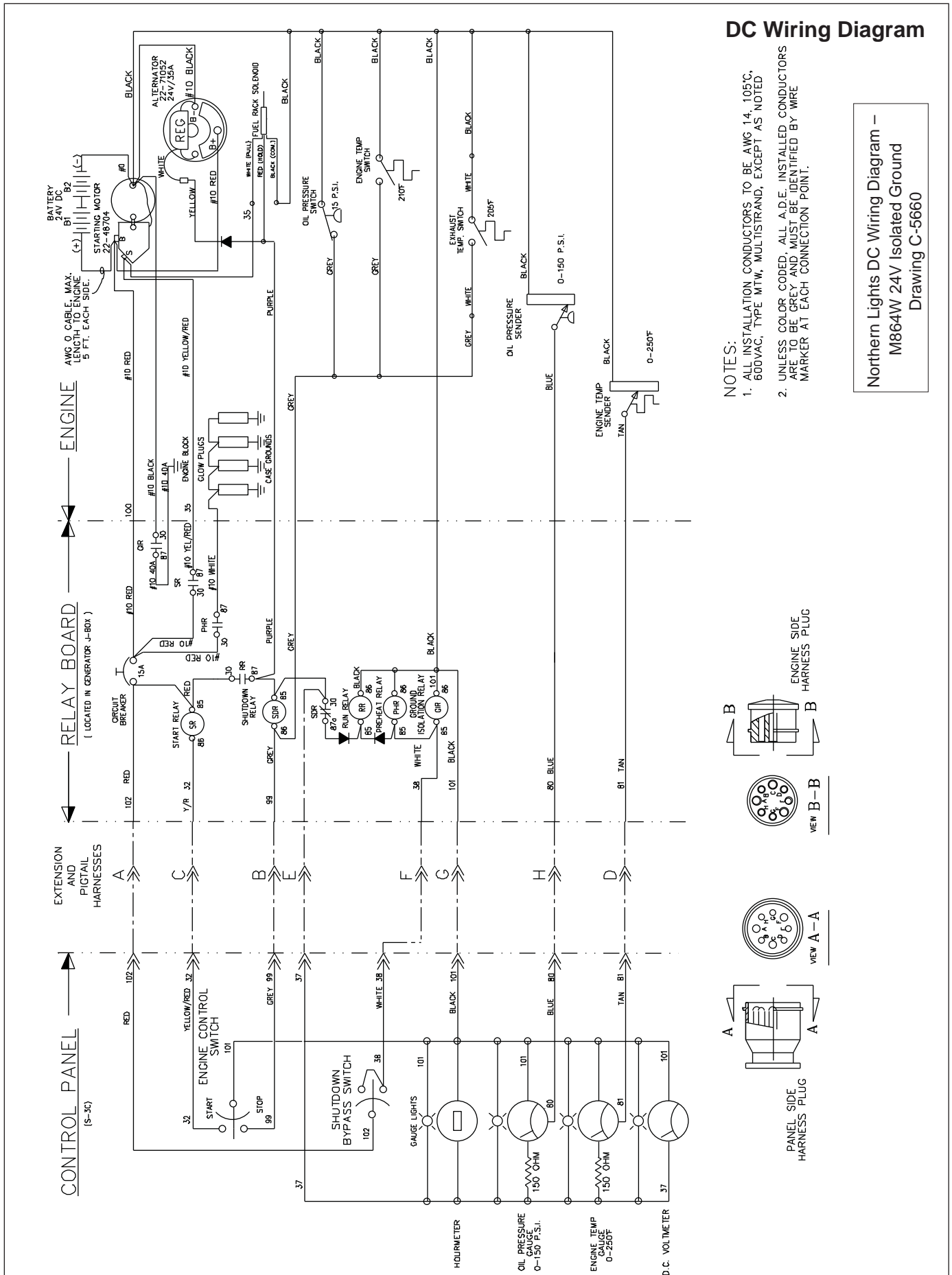

DC Wiring Diagram

NOTES:

1. ALL INSTALLATION CONDUCTORS TO BE AWG 14, 105°C, 600VAC, TYPE MTW, MULTISTRAND, EXCEPT AS NOTED.
2. UNLESS COLOR CODED, ALL A.D.E. INSTALLED CONDUCTORS ARE TO BE GREY AND MUST BE IDENTIFIED BY WIRE MARKER AT EACH CONNECTION POINT.

Northern Lights DC Wiring Diagram –
M864W 24V Isolated Ground
Drawing C-5660

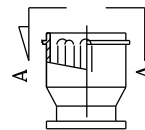
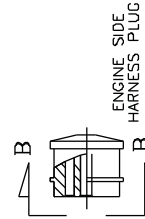

AC Wiring Diagram

Northern Lights AC Wiring Diagram –
DST-100-2FAK Voltage Regulator
Drawing B-8280D

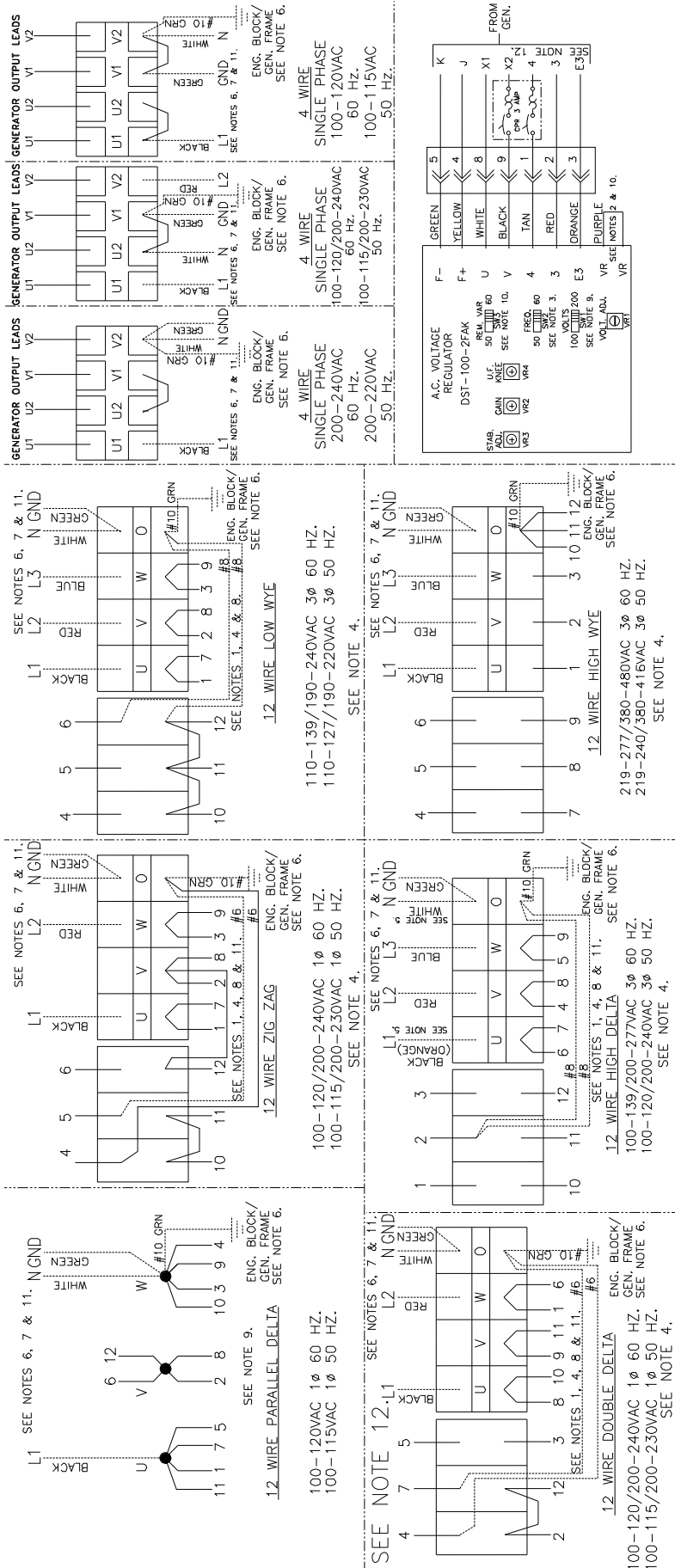

NOTES:

- ALL A.D.E. INSTALLED CONDUCTORS ARE TO BE TYPE 1. ALL A.D.E. INSTALLED CONDUCTORS ARE TO BE TYPE 1. ALL A.D.E. INSTALLED CONDUCTORS ARE TO BE TYPE 1.
- FOR REMOTE VOLTAGE ADJUST RHEOSTAT OUT JUMPER AND SPICE INTO PURPLE LEADS.
- SET SW2 FOR CURRENT APPLICATION (50 OR 60 HZ).
- DELETE NEUTRAL CONDUCTOR (AND JUMPER IF PRESENT), IF LOWER VOLTAGE IS NOT REQUIRED.
- LINE ONE (HIGH LEG) TO BE MARKED ORANGE WHEN NEUTRAL IS PRESENT IN A COLOR CODE.
- MARINE GENSETS ARE GROUNDED BY CUSTOMER. AT CUSTOMER'S DISCRETION, INDUSTRIAL GENSETS ARE TO BE GROUNDED IN ACCORDANCE WITH THE NATIONAL ELECTRICAL CODE AND ANY APPLICABLE LOCAL CODES.
- THICK HIDDEN (DASHED) LINES INDICATE CUSTOMER SUPPLIED AND CONNECTED IN OUTPUT CONDUCTORS. SIZING TO BE DETERMINED PER INSTALLATION.
- NEUTRAL CONDUCTORS SIZED FOR 33kW UNITS AT THE LOWEST LISTED VOLTAGE. CONSULT A.D.E. ENGINEERING FOR CONDUCTOR SIZING @ OTHER GENSET VOLTAGE/KW RATINGS.
- AVR INPUT SENSING SWITCH SW1 IS TO BE SET TO THE 200V POSITION FOR ALL VOLTAGES EXCEPT STRAIGHT 100-120VAC APPLICATIONS.
- SET SW3 PER APPLICATION IF REMOTE VOLTAGE ADJUST RHEOSTAT IS USED.
- TERMINAL BLOCKS WILL NOT ACCOMMODATE LARGER GAUGE CONDUCTORS. IF REQUIRED, REMOVE AFFECTED LEADS FROM BLOCK (MINOR GAUGE) AND MAKE CONNECTIONS USING BOLT, ELECTRICAL TAPE, AND WIRE CONNECTING BOLT.
- THE DOUBLE DELTA CONFIGURATION REQUIRES THE AVR TO BE REWIRED AS FOLLOWS: DISCONNECT LEADS 3 AND 4. FROM AVR. CONNECT LEAD 3 TO AVR TERM. 4 (THROUGH C.B.). CONNECT LEAD 4 TO AVR TERM. 3. DISCONNECT LEAD E3 FROM AVR AND ISOLATE. CONNECT AVR TERMINAL E3 TO MAIN OUTPUT BLOCK TERM. "W", USING A RED AWG 14 LEAD (SEE NOTE 1).

Notes



4420 14th Ave. NW., Seattle WA 98107

Tel: (206) 789-3880 • 1-800-762-0165 • Fax: (206) 782-5455

Northern Lights and Lugger are registered trademarks of Northern Lights, Inc.

© 2007 All rights reserved. Litho USA.